

Copyright!

L'Architecte pratique

Nº 30/32 nouvelle édition

The Practical Architect

No.30/32 new series

El Arquitecto práctico

No30/32 nueva Serie

O Architecto practico

No.30/32 nueva Serie

Az Ügyes Építőmester

30/32 sz. új sorozat

DER

GESCHICKTE BAUMEISTER

No. 30 und 32 neue Folge

Verlag der "Club van Ankervrienden", Niederlande

De
Bekwame Bouwmeester

No.30/32 nieuwe reeks

Den flinke Bygmester

No.30/32 ny Serie

L'Architetto pratico

No.30/32 nuovo seguito

Architectul practic

No.30/32 nouă ediția

Zręczny budowniczy

No.30/32 nowej edycji

Искусный Архитекторъ

No.30/32 нового изданія.

Obratný stavitel

No.30/32 nové řady

Nachdruck verboten! — Reproduction interdite!

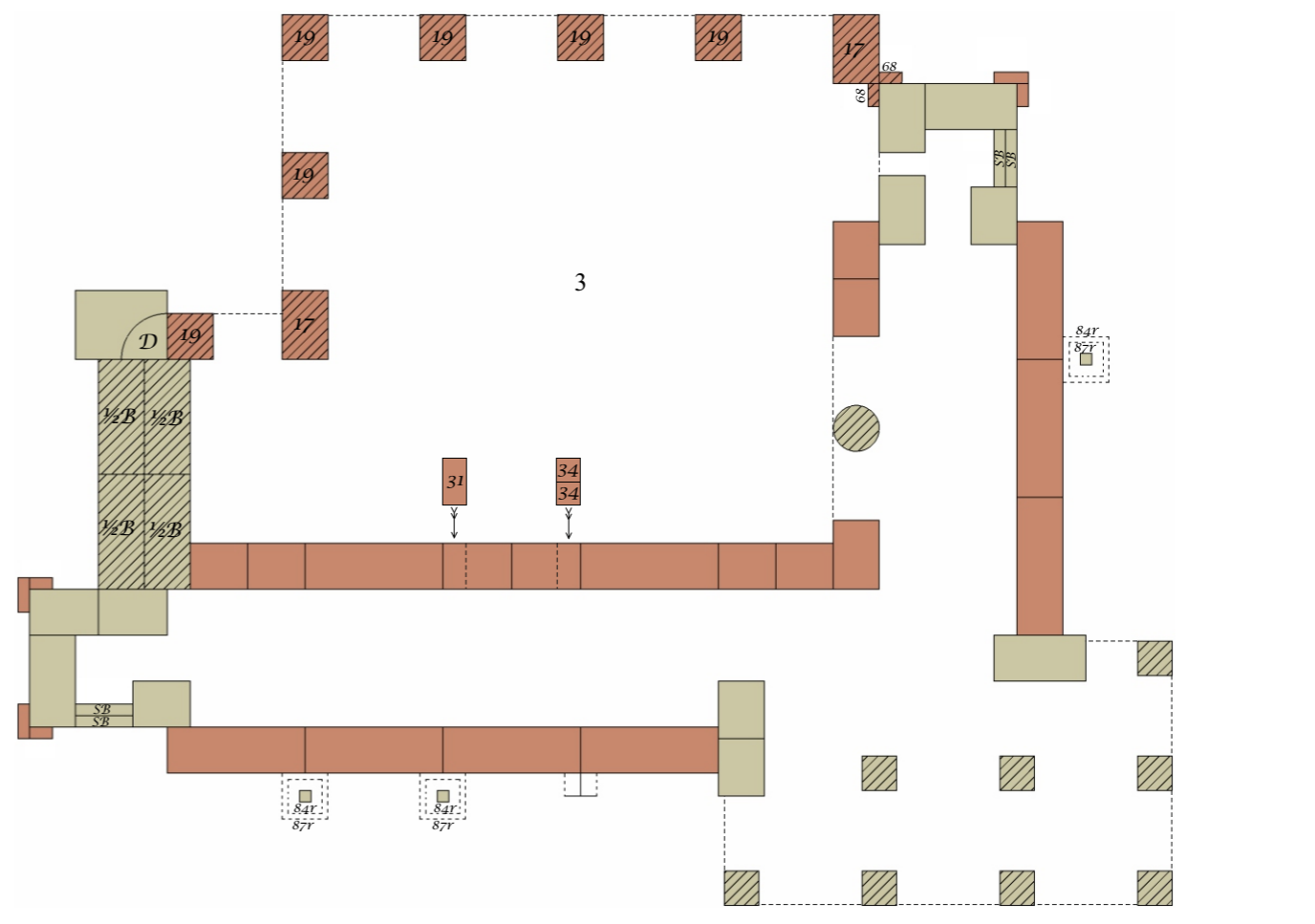
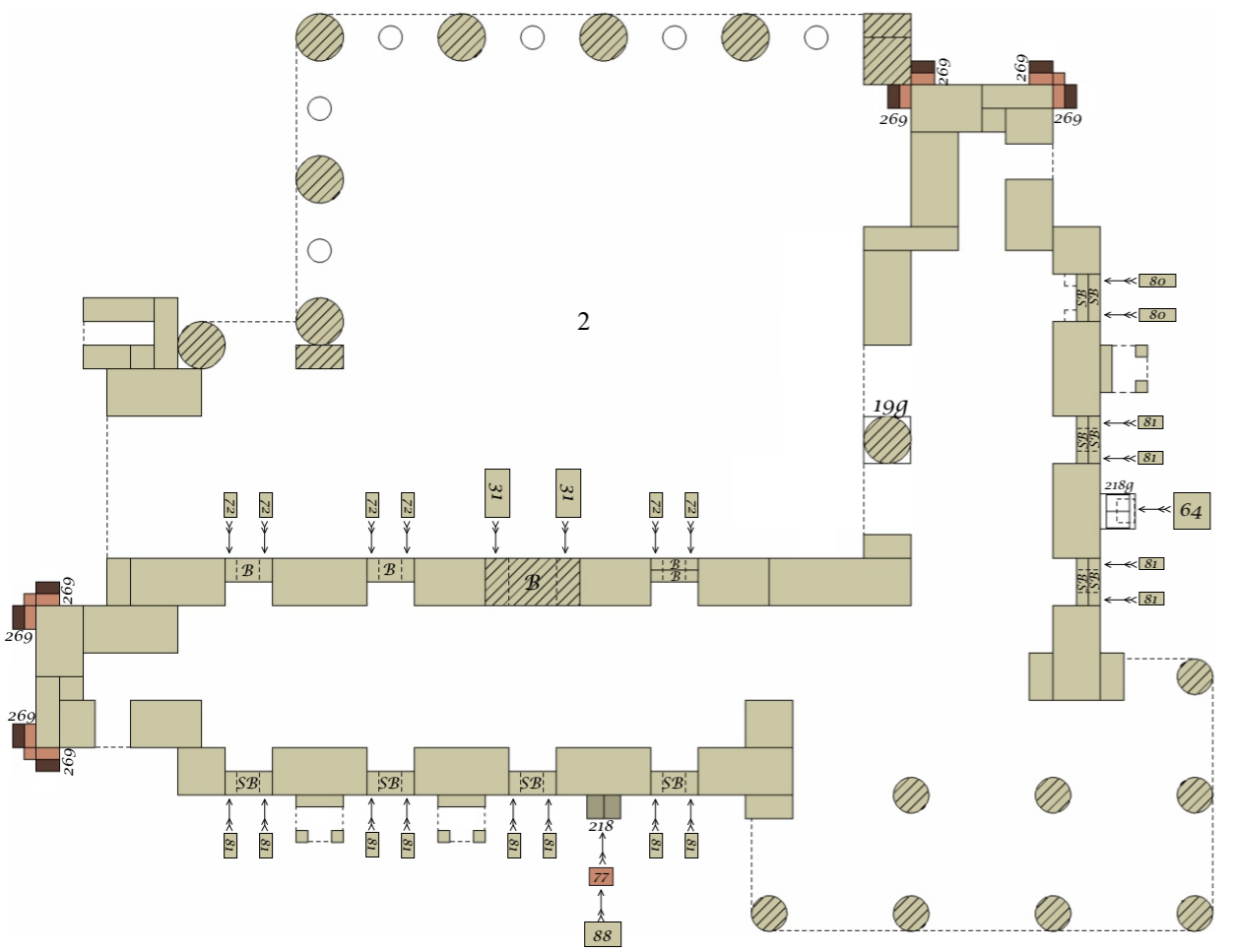
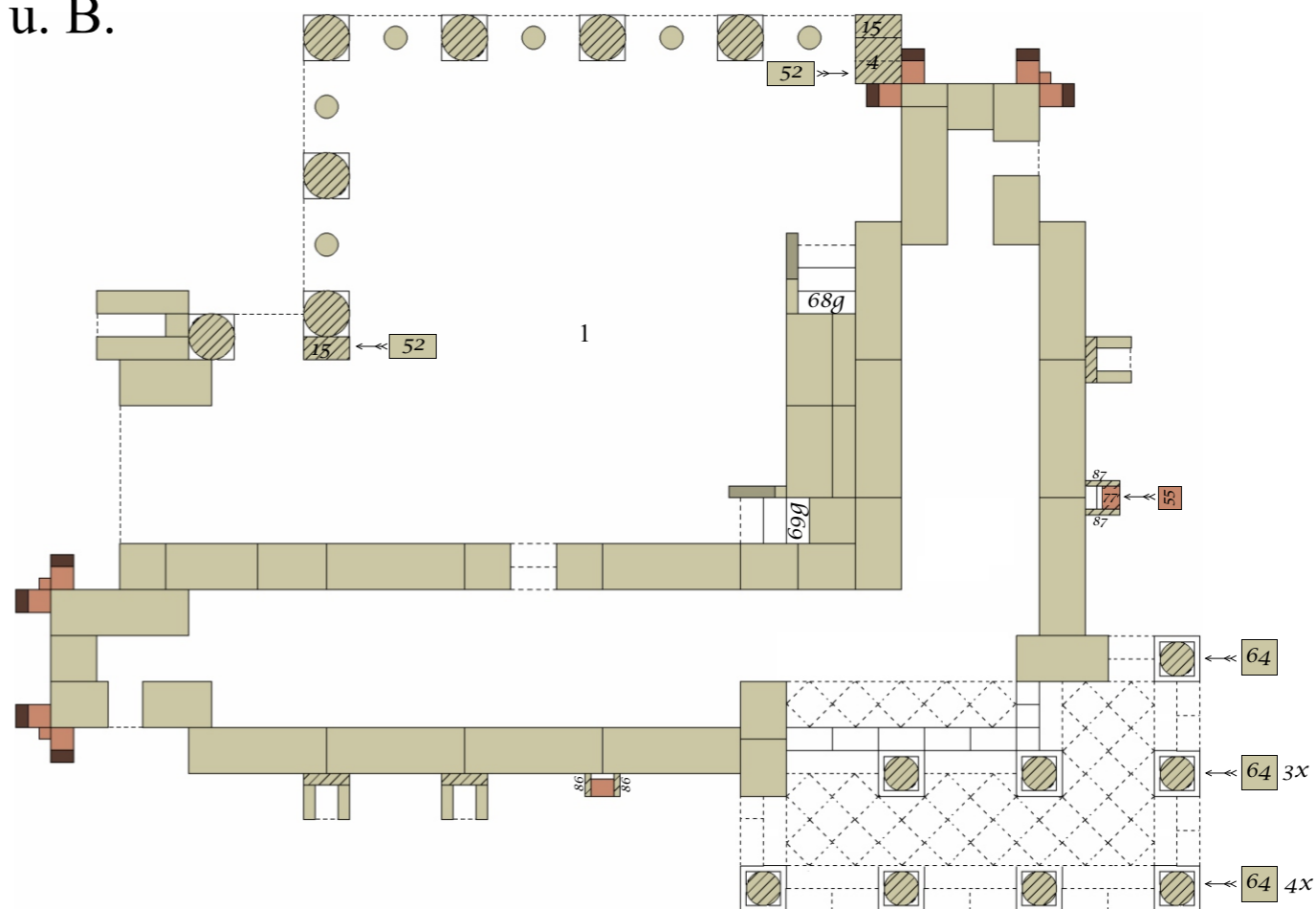
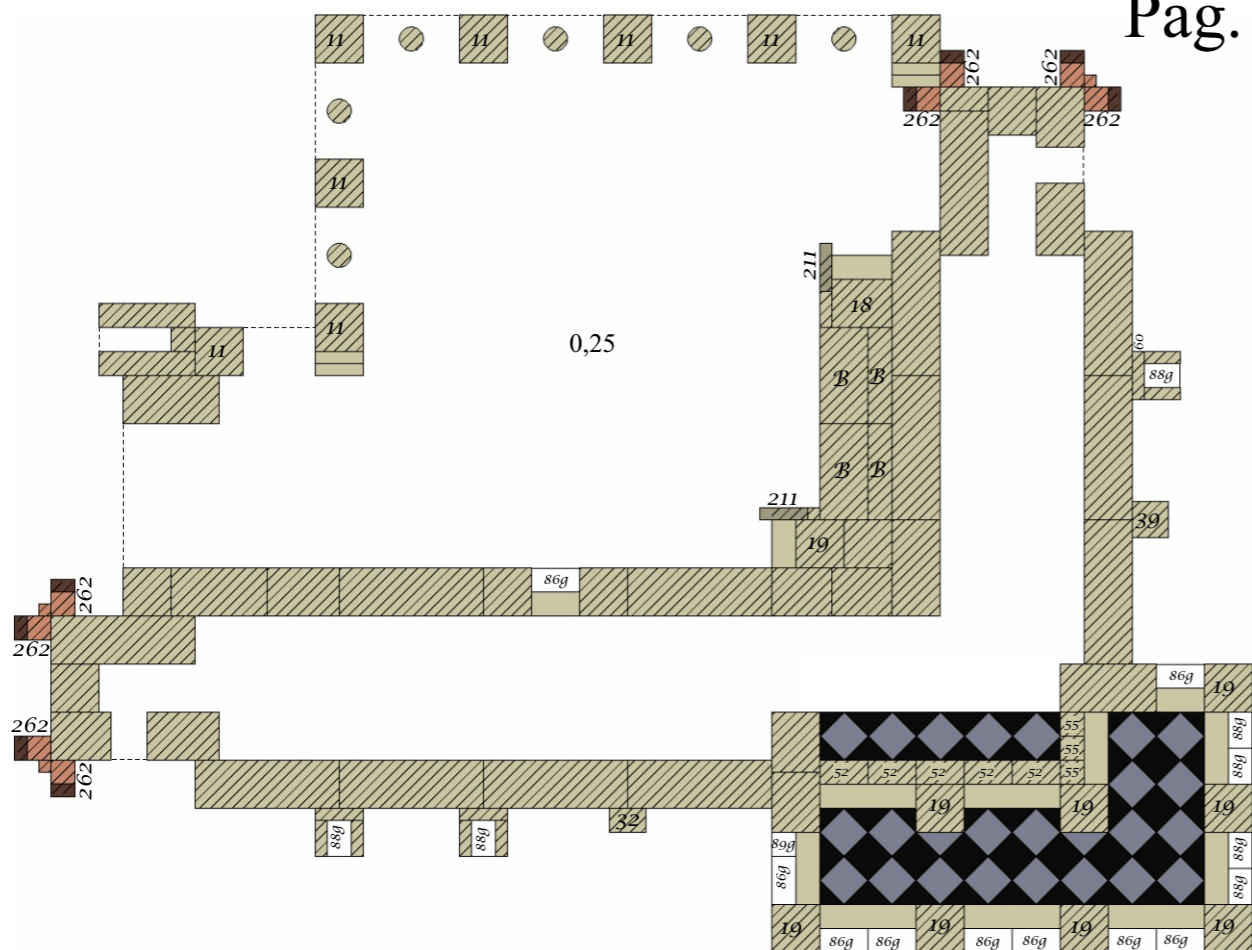

N^o 30. 50 25 0 50 100 150 200 250 300 350 400 450 500 550 600 650 700 mm.

B. I. K. I-1

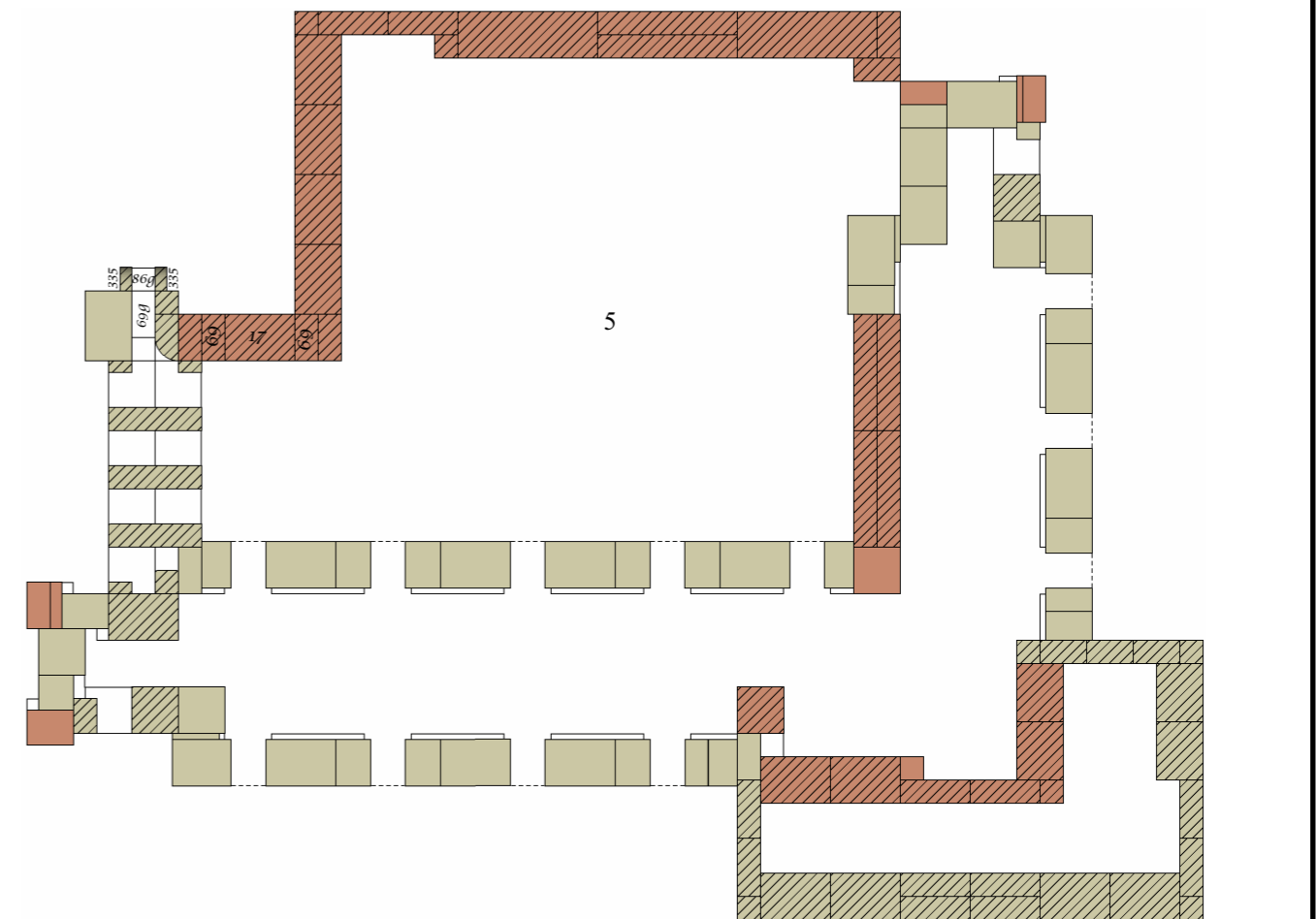
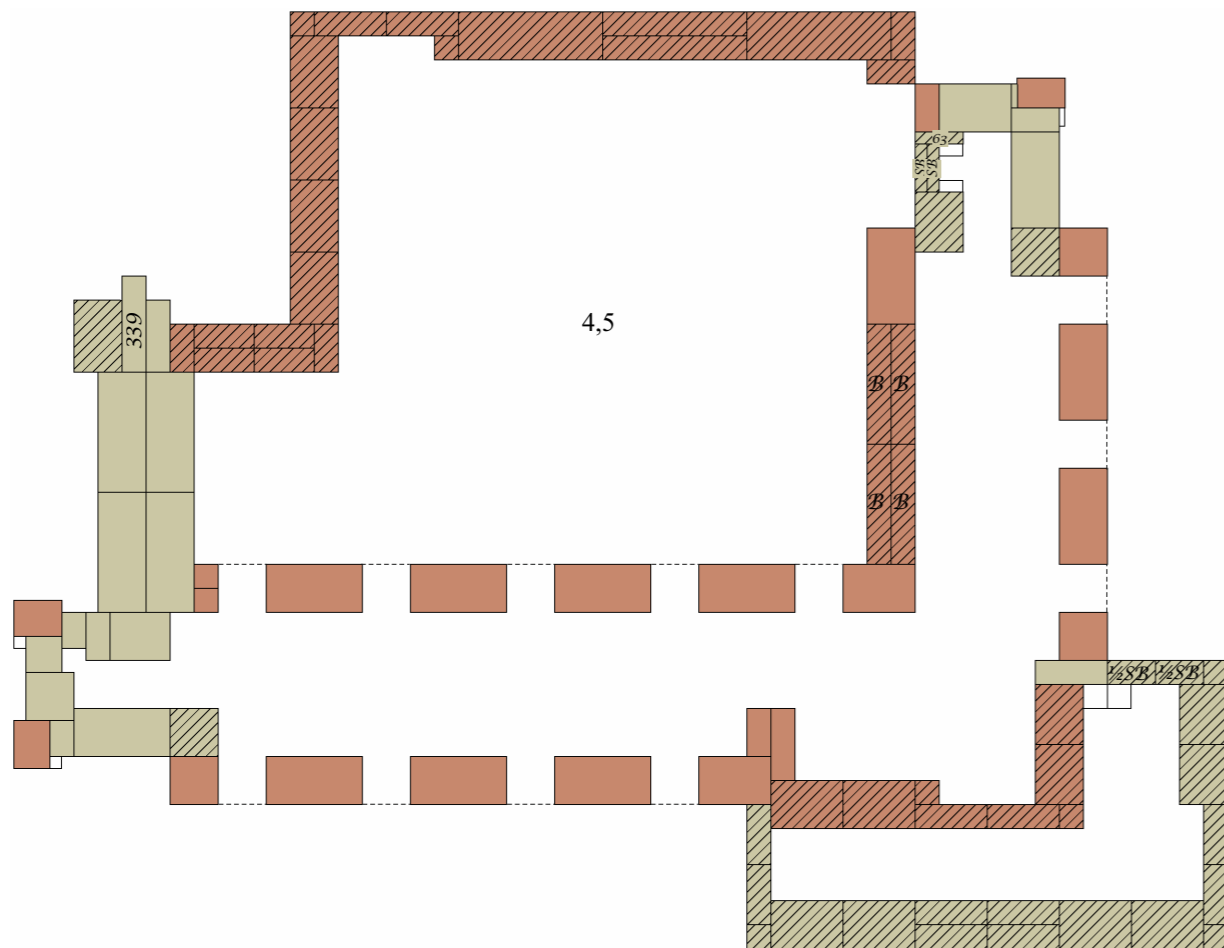
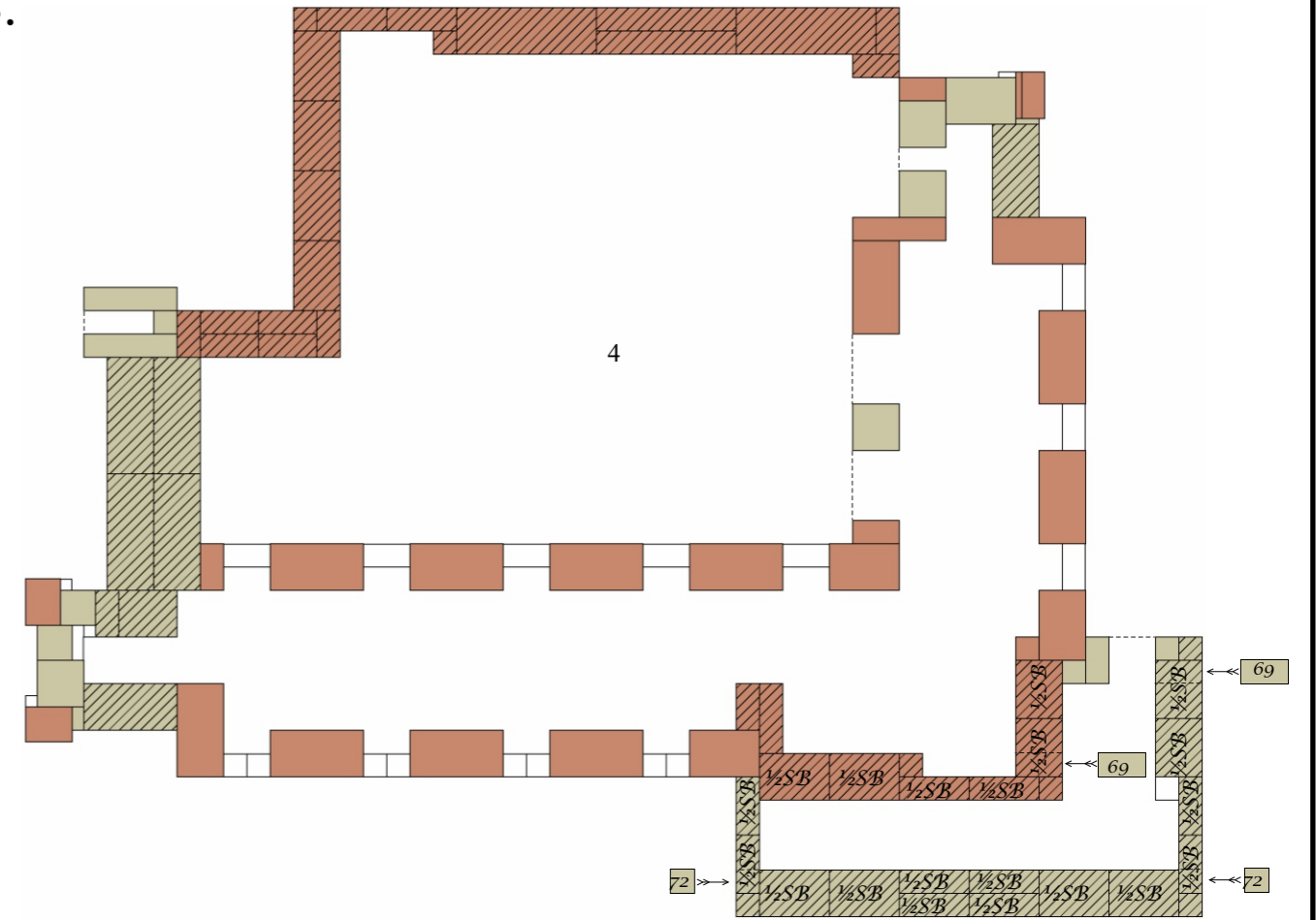
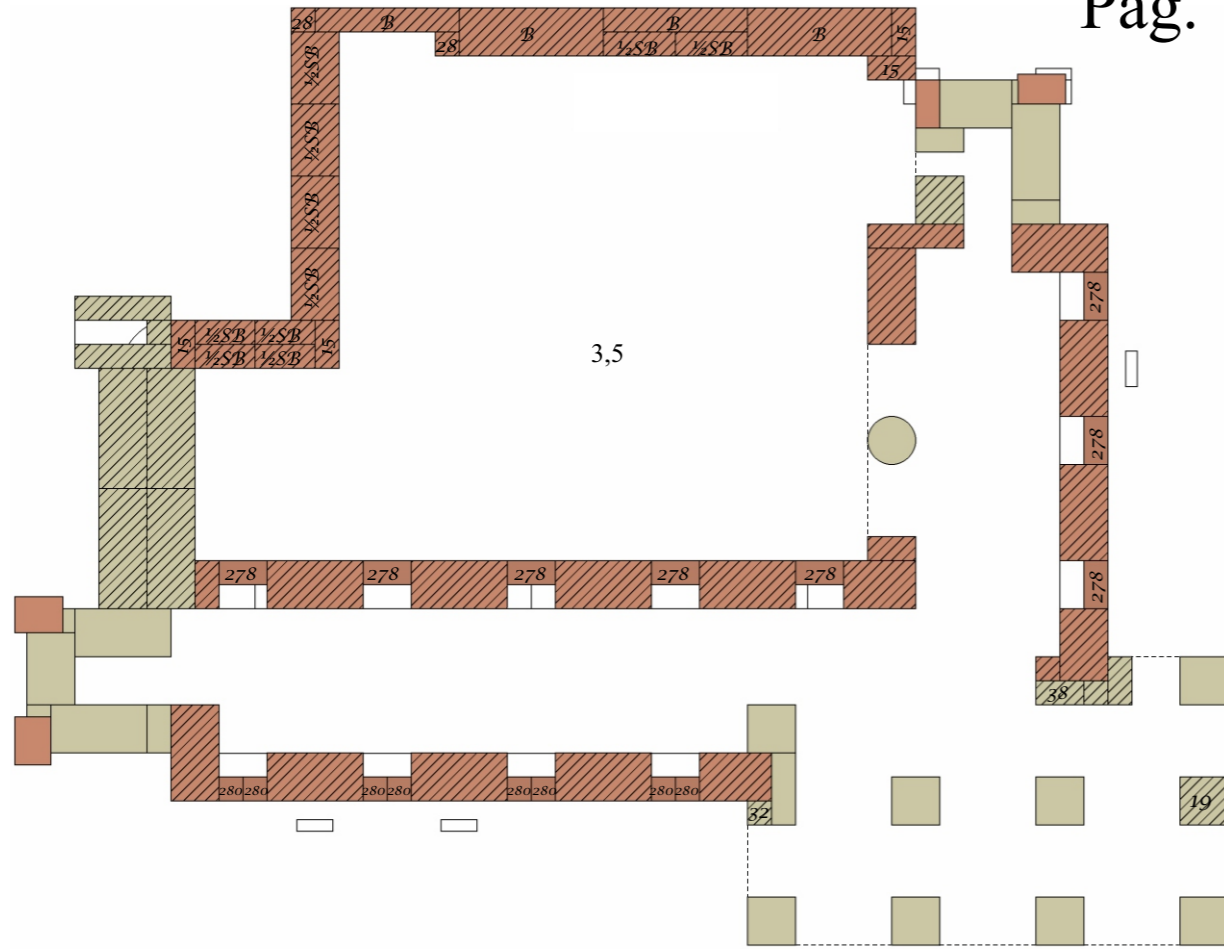

N^o 30.

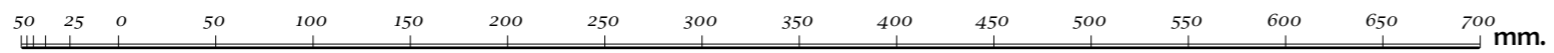

B. I. K. I-2

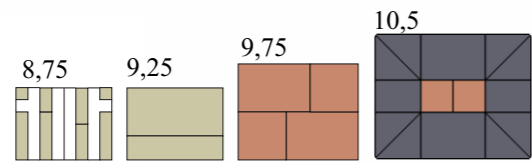
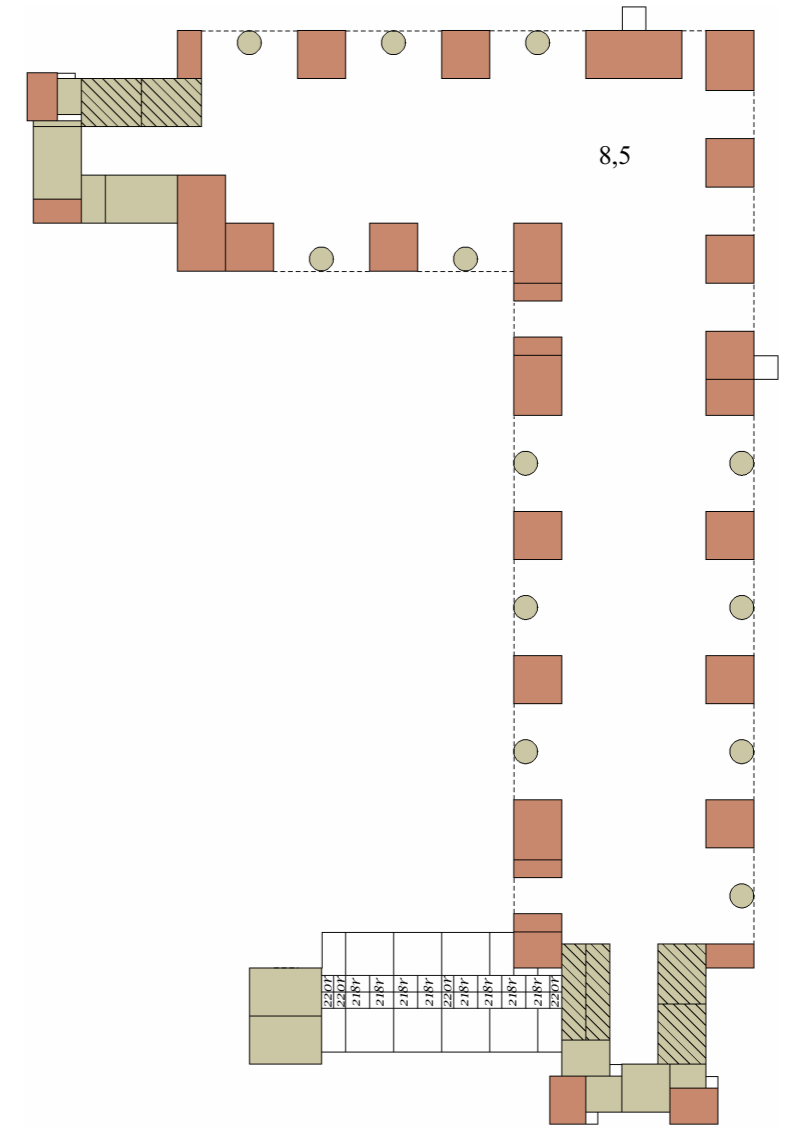
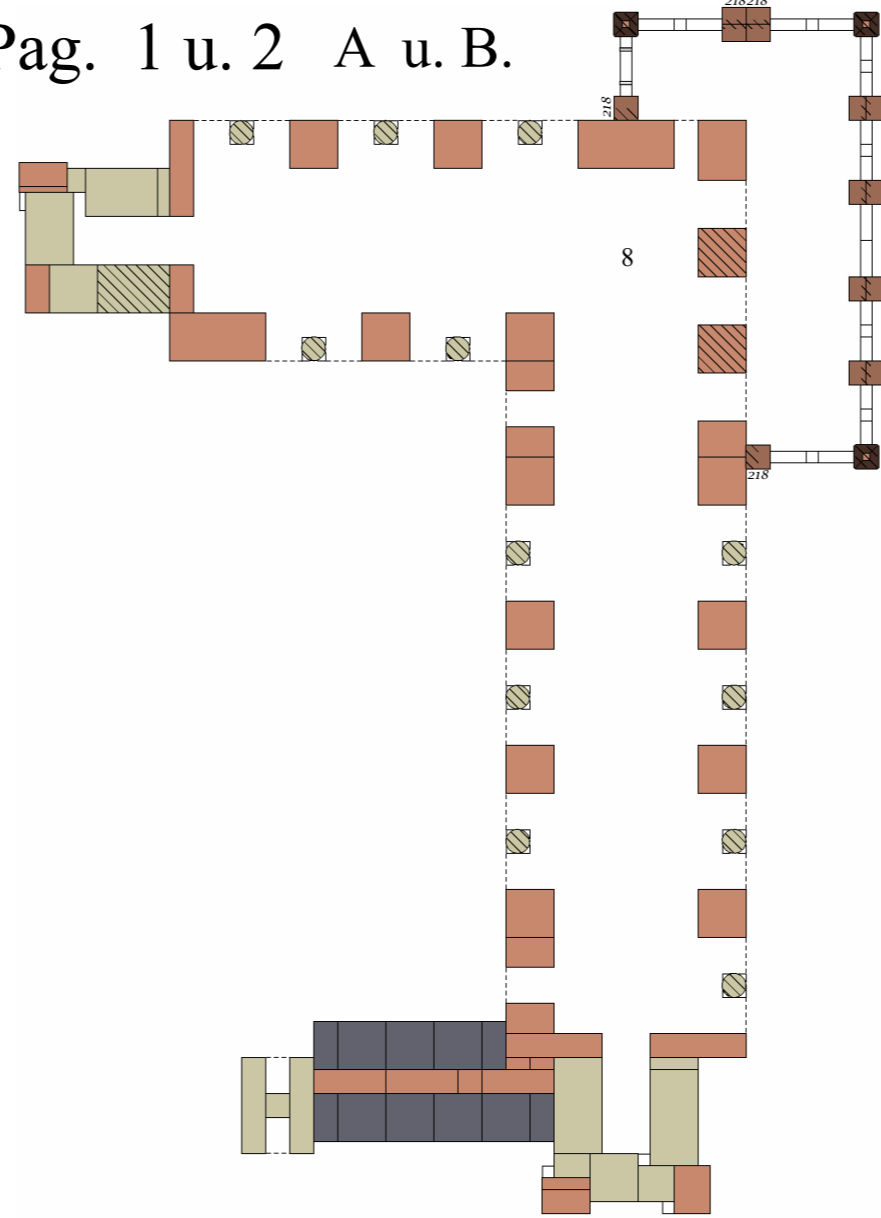
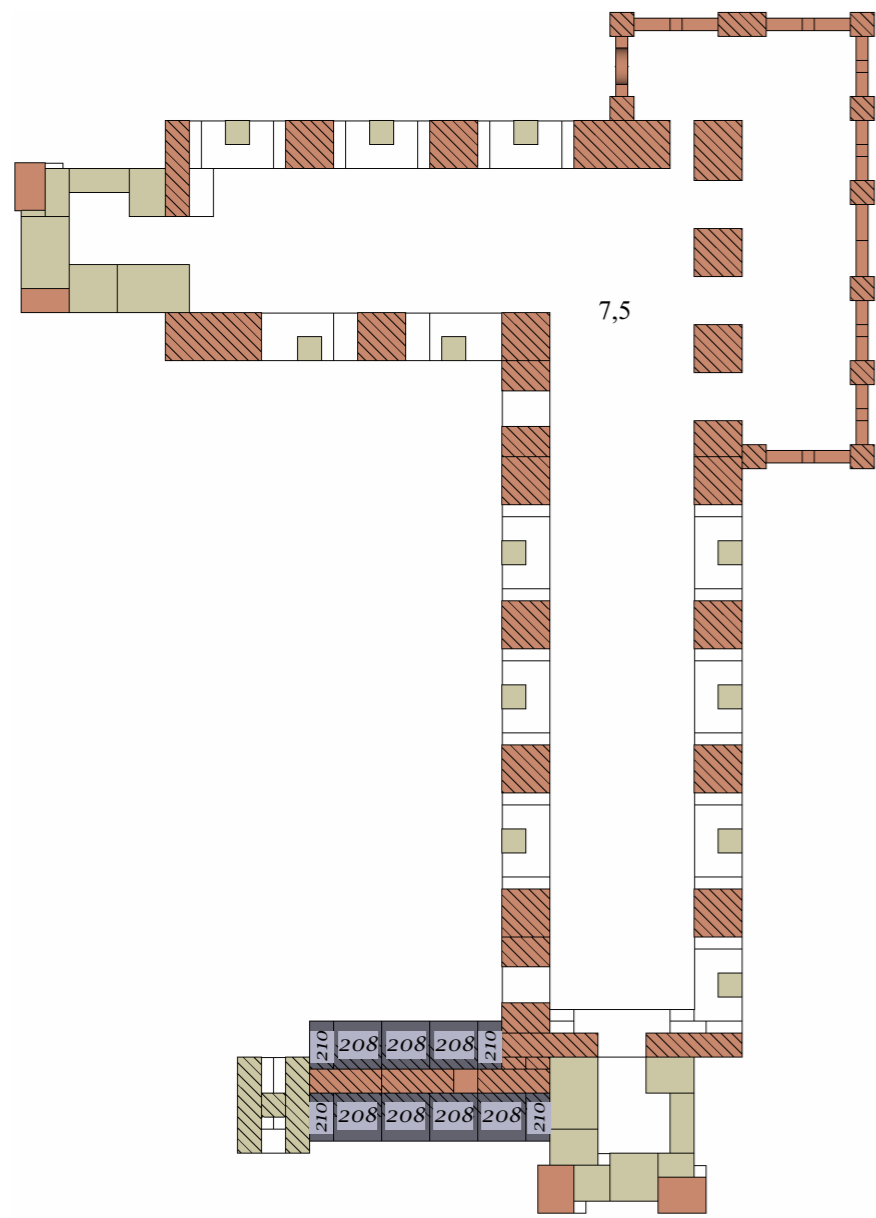

Kleiner Torturm

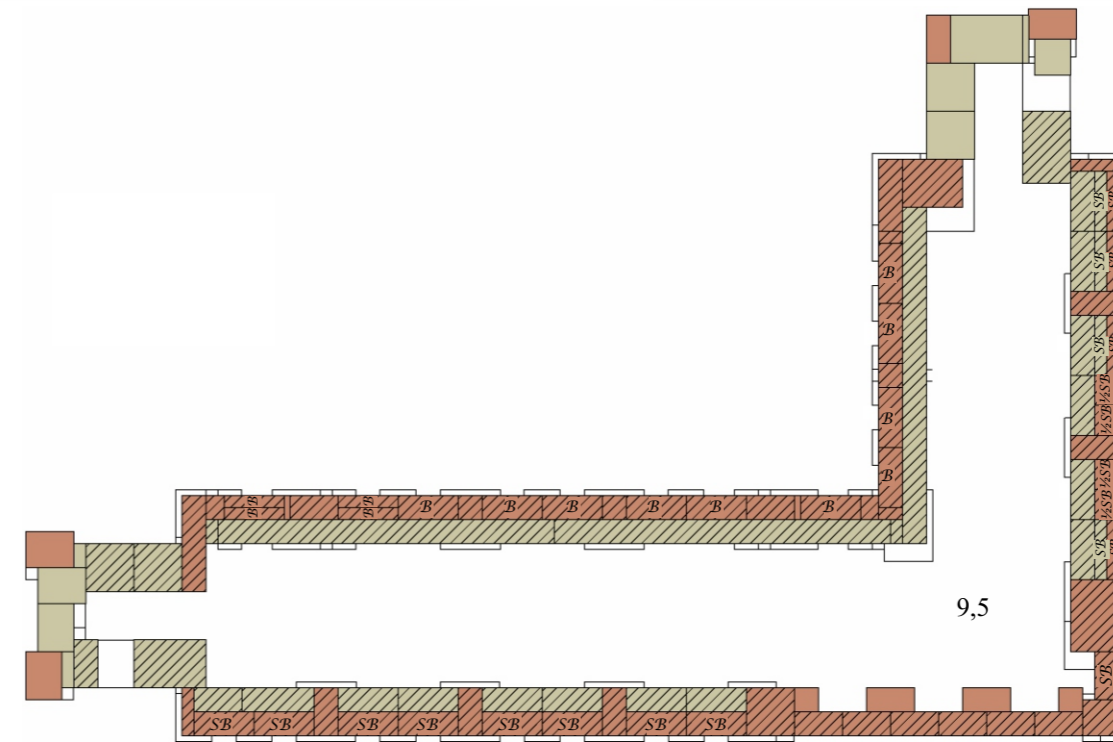
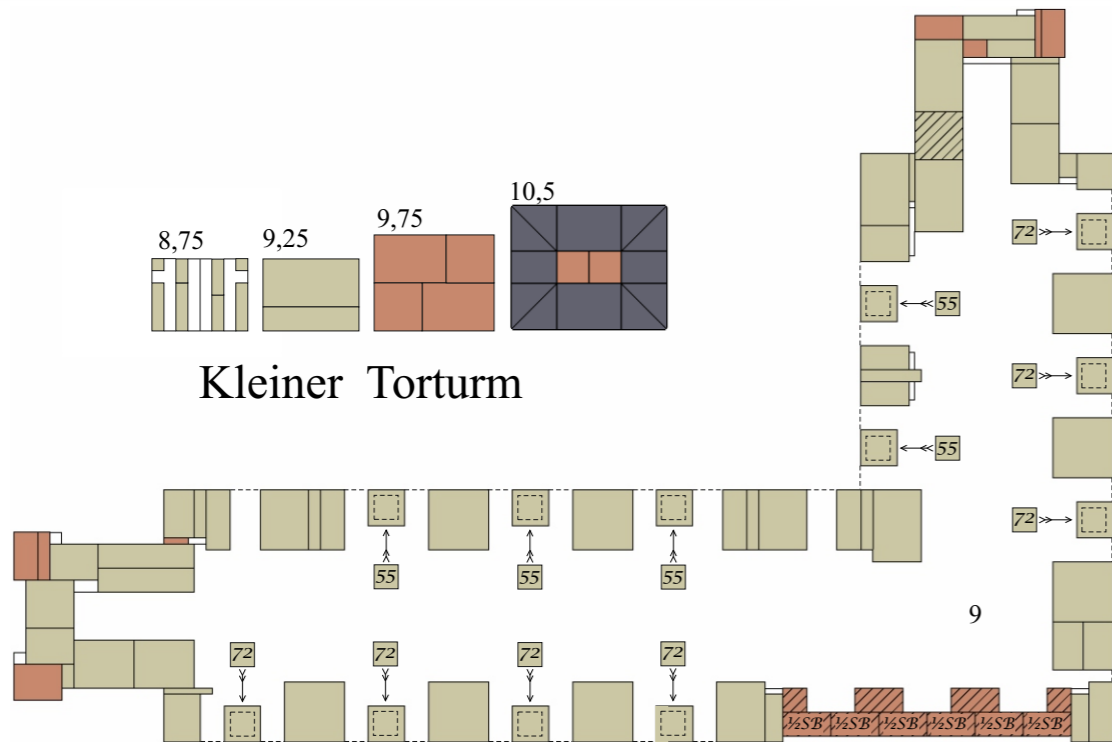

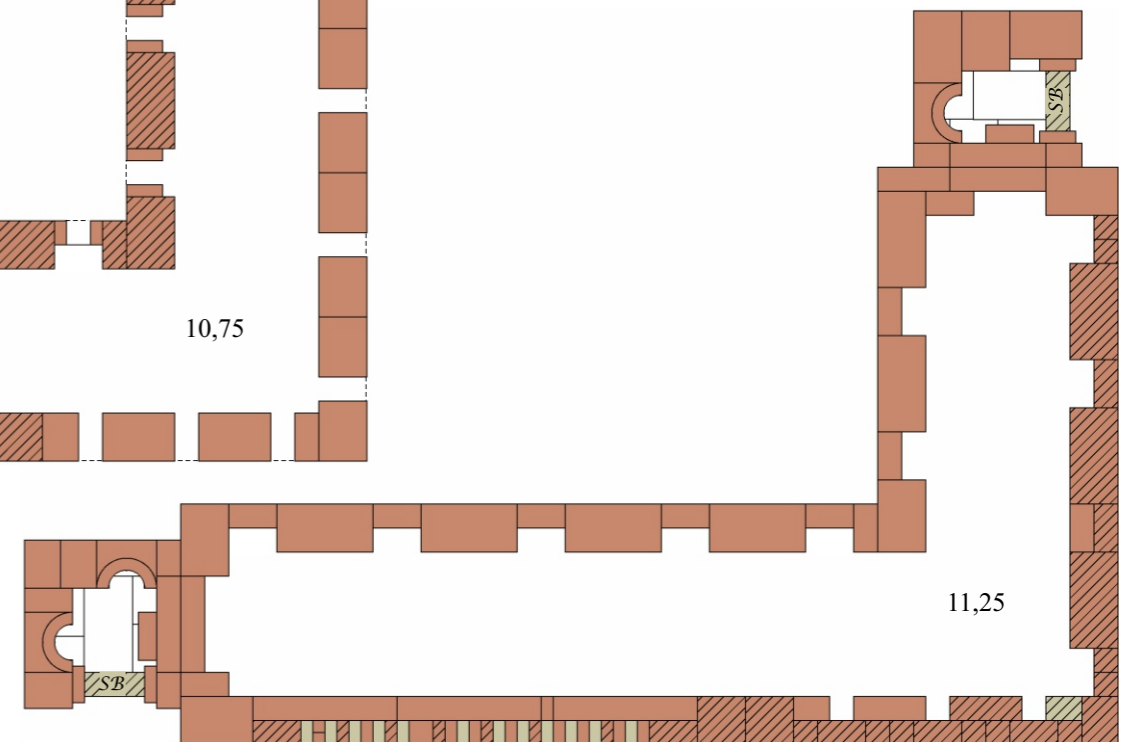
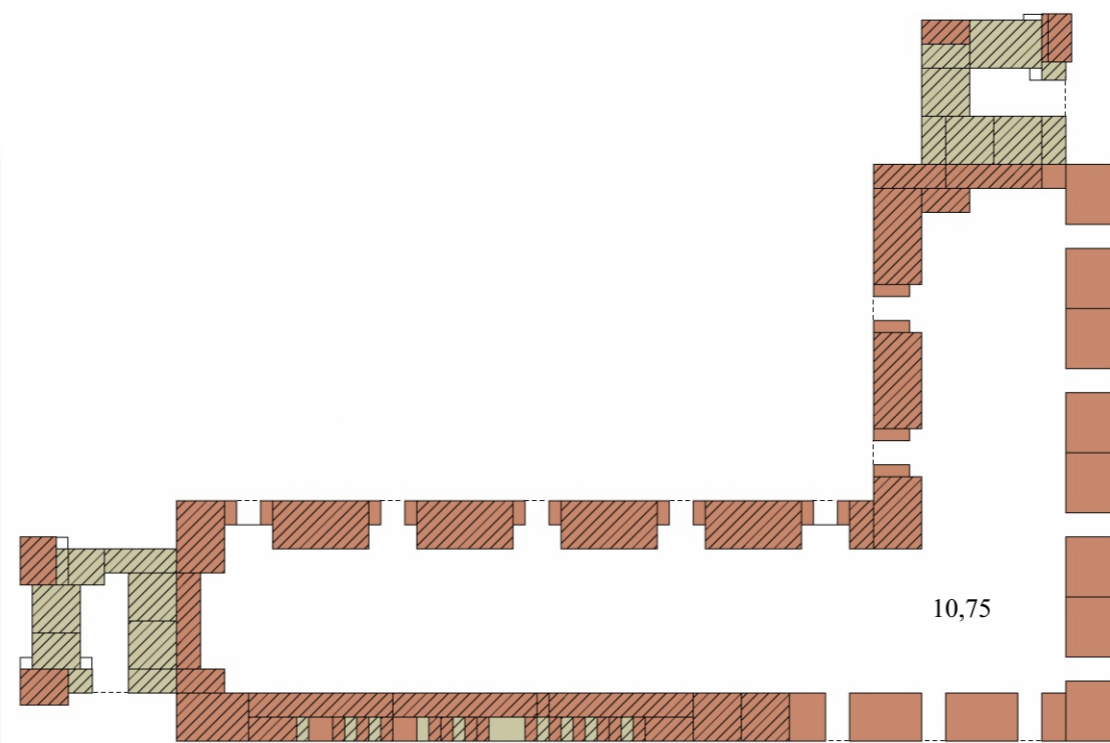
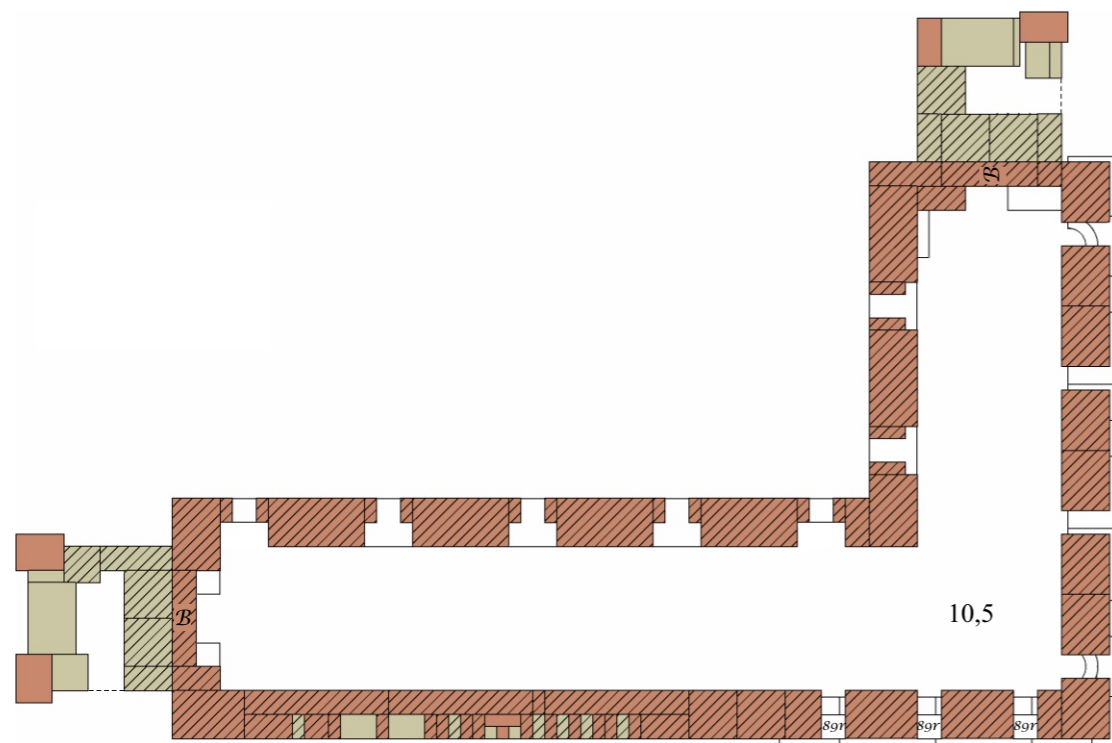
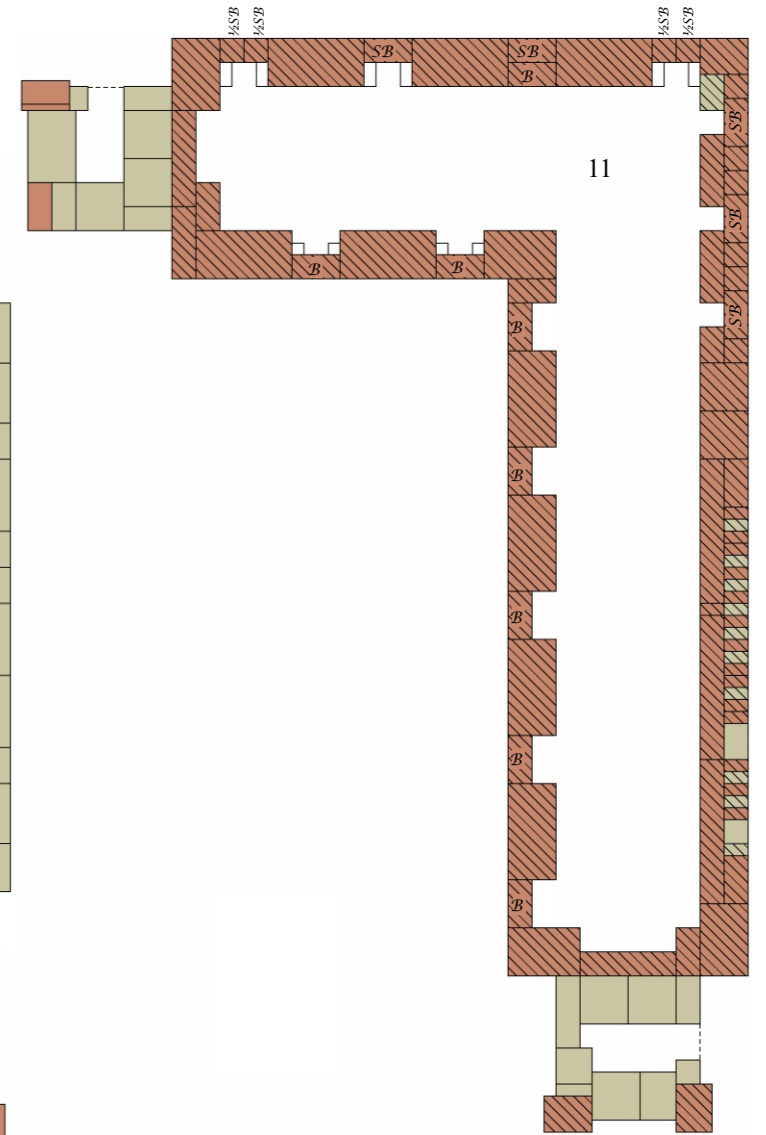
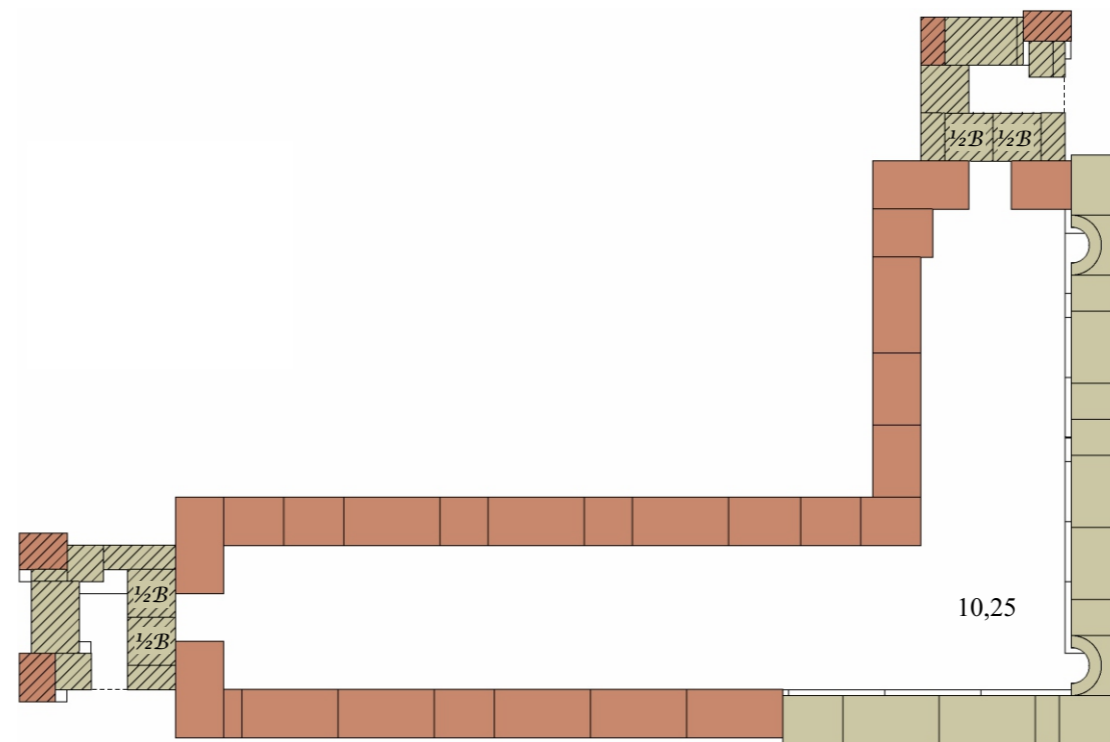
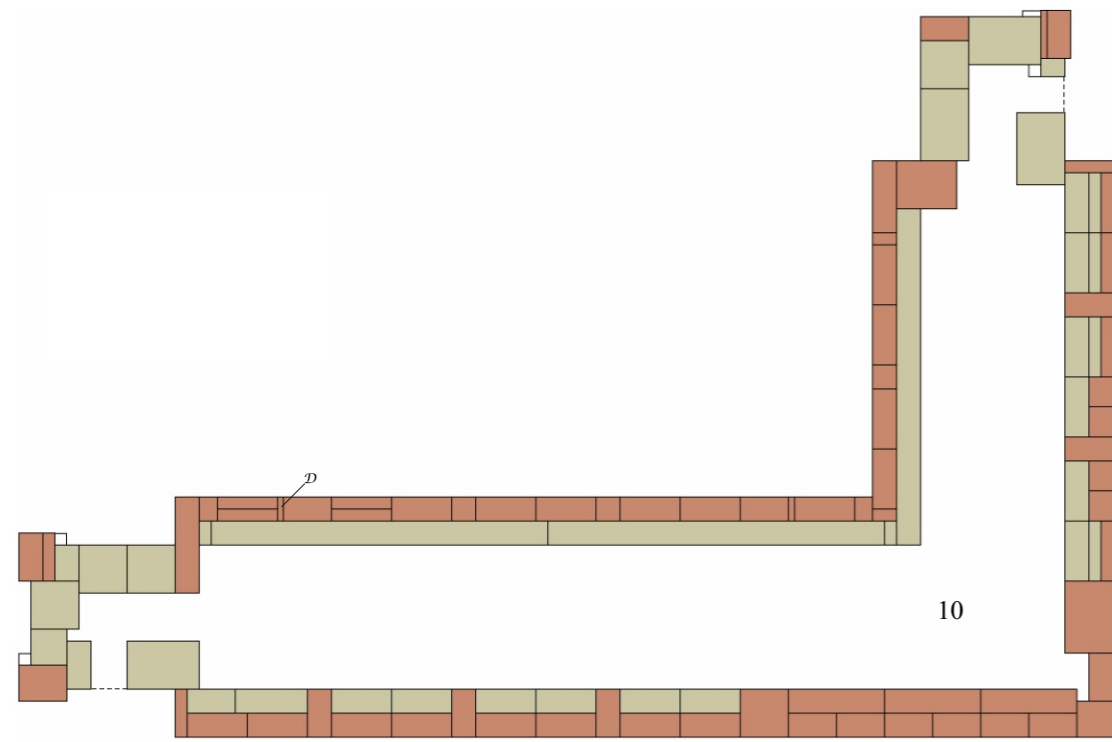

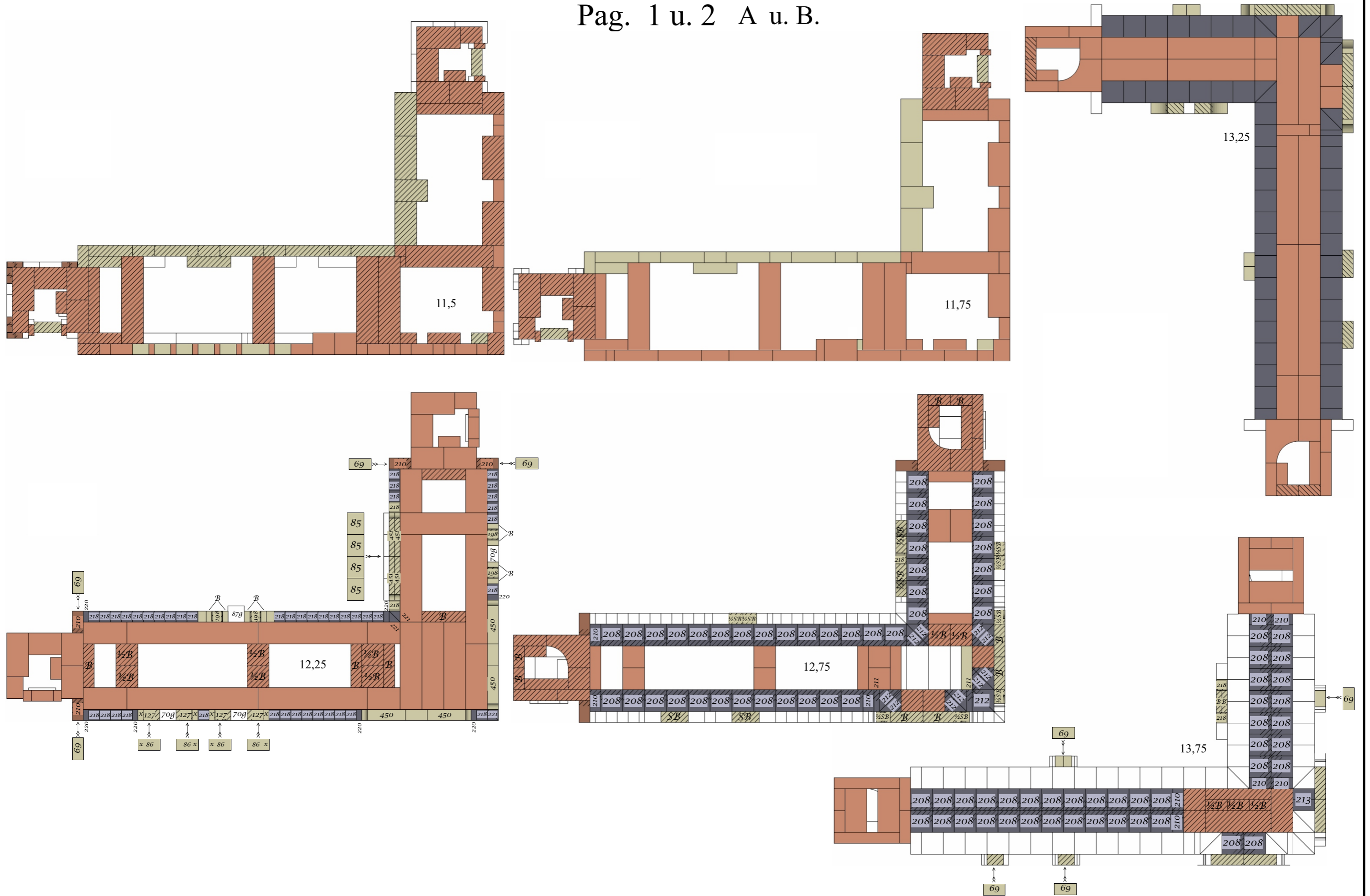

N^o 30.

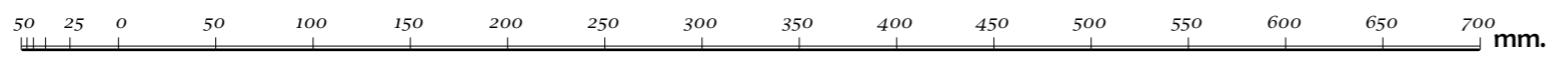

B. I. K. I-6

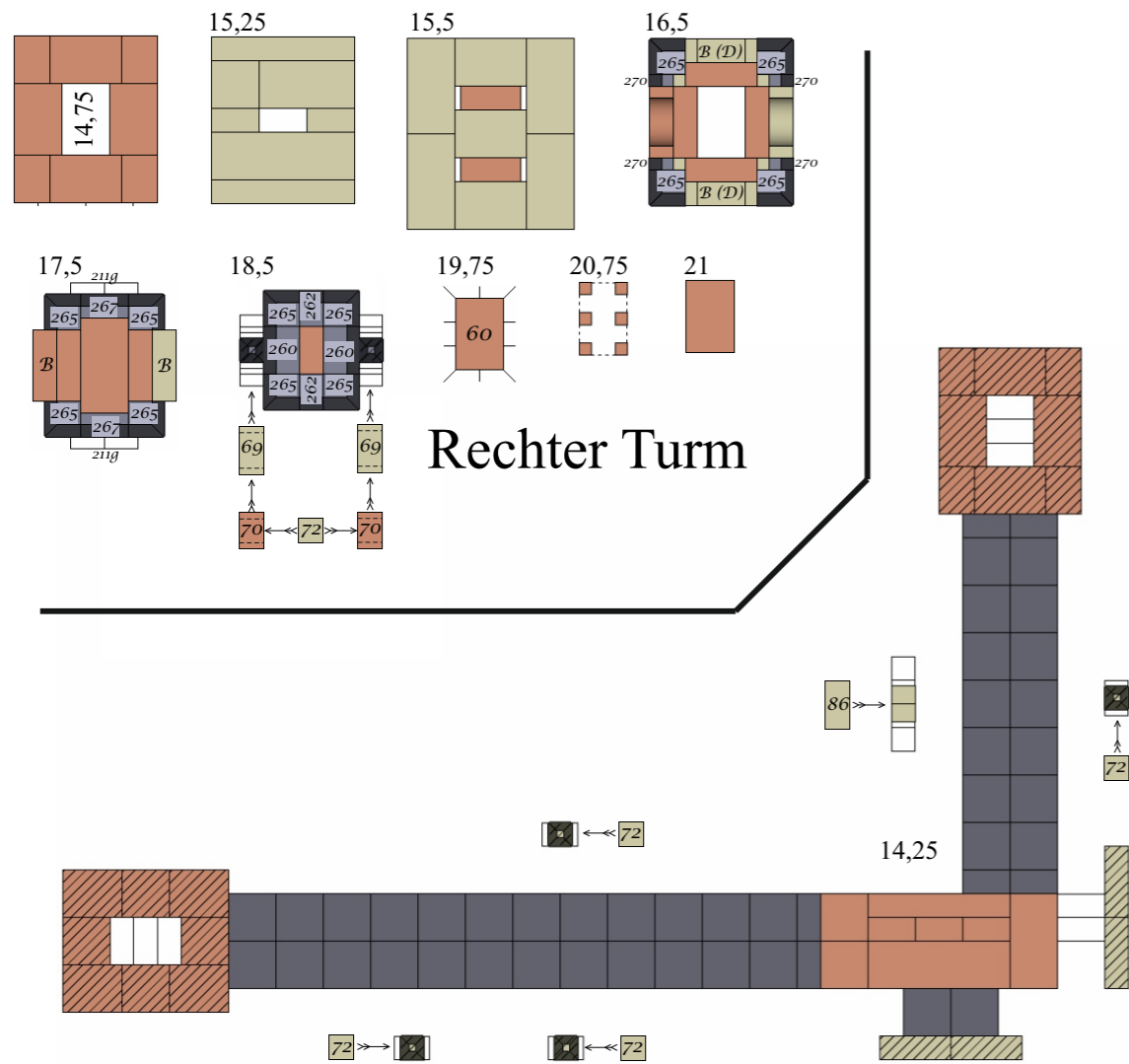

Linker Turm

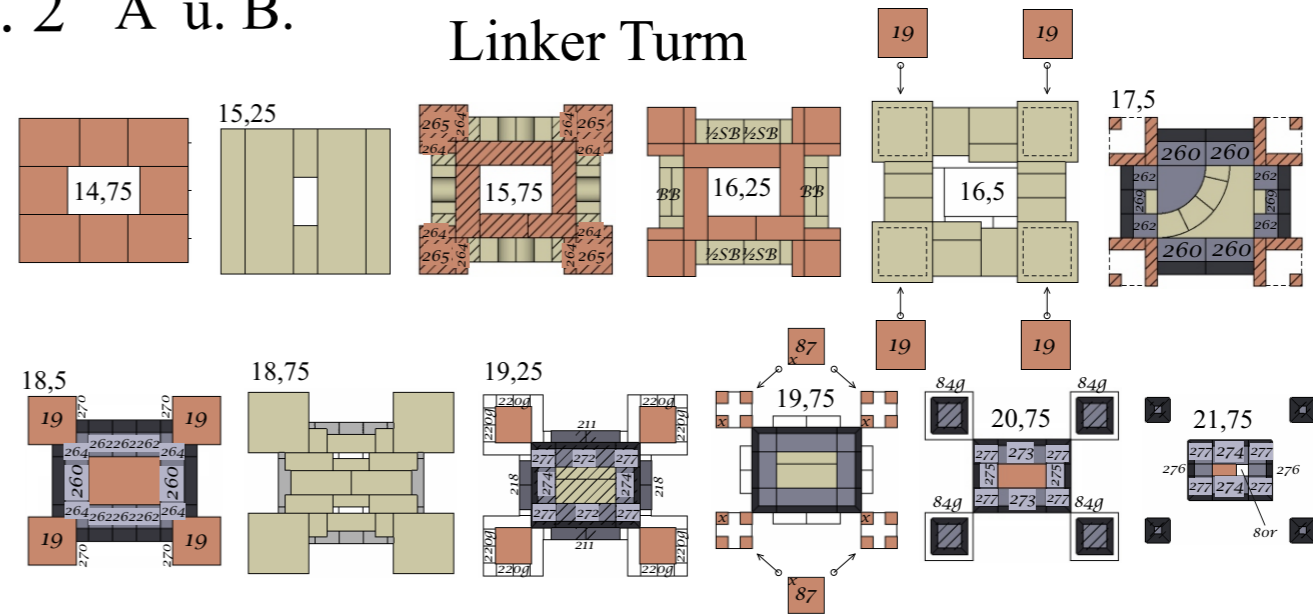

Zentraler Turm

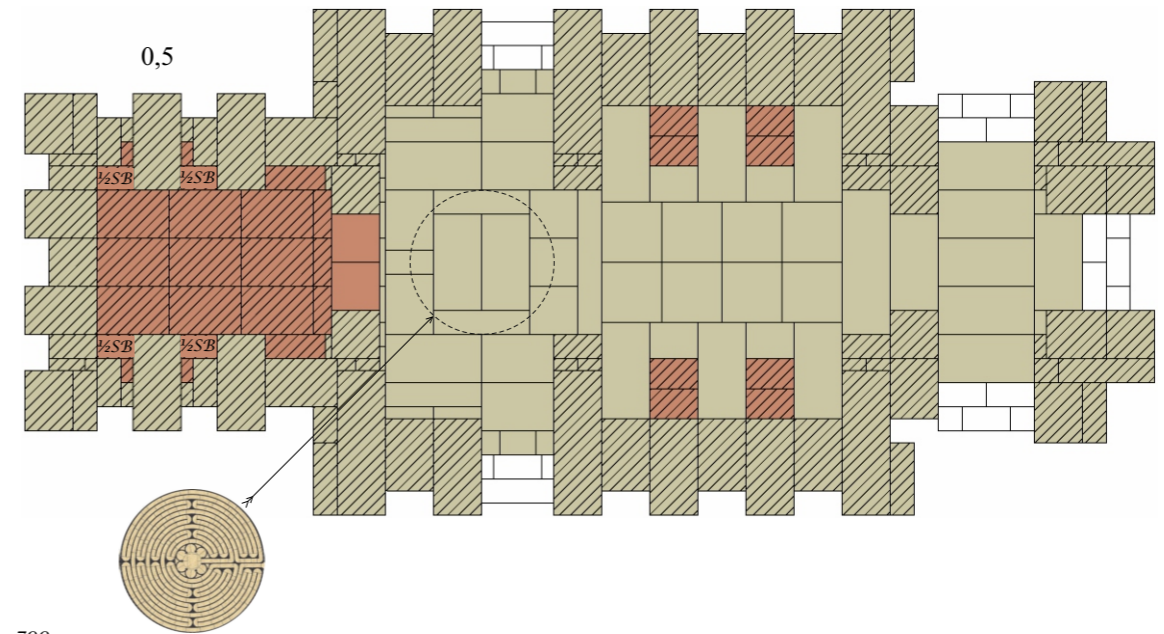
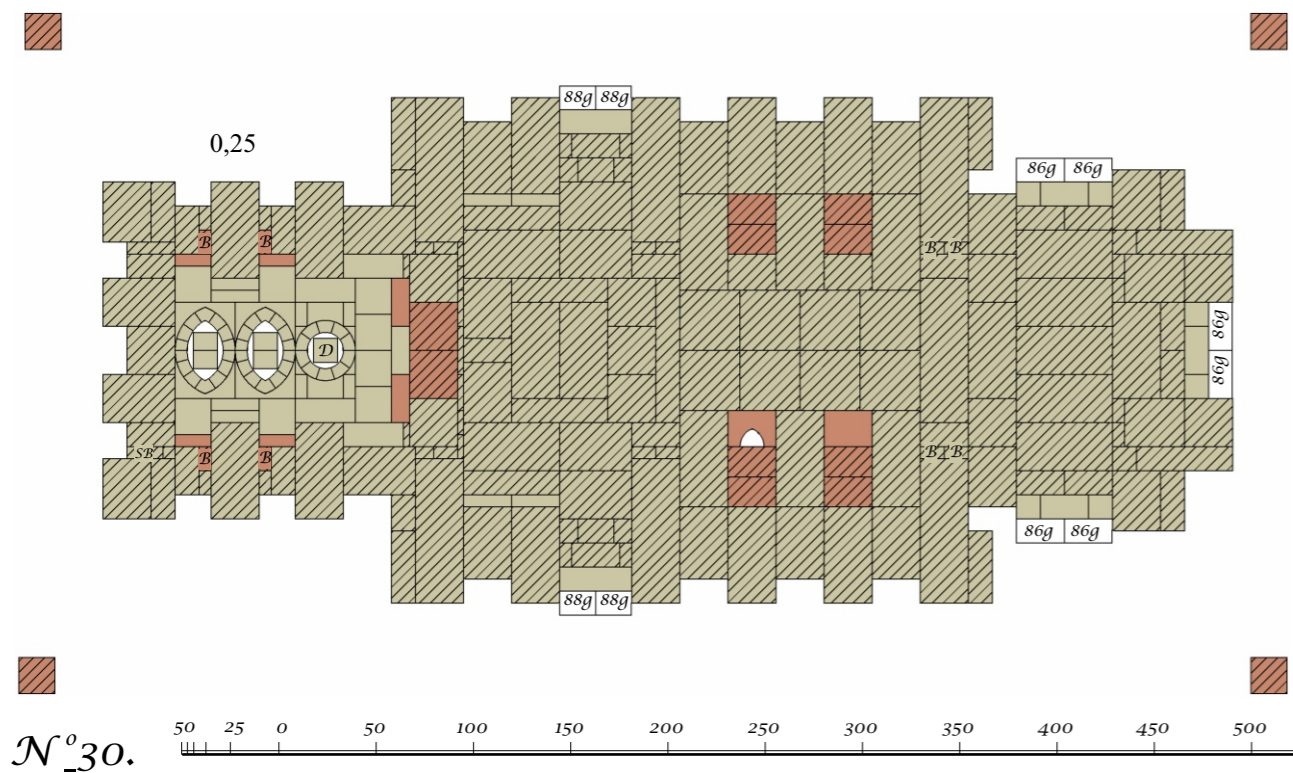
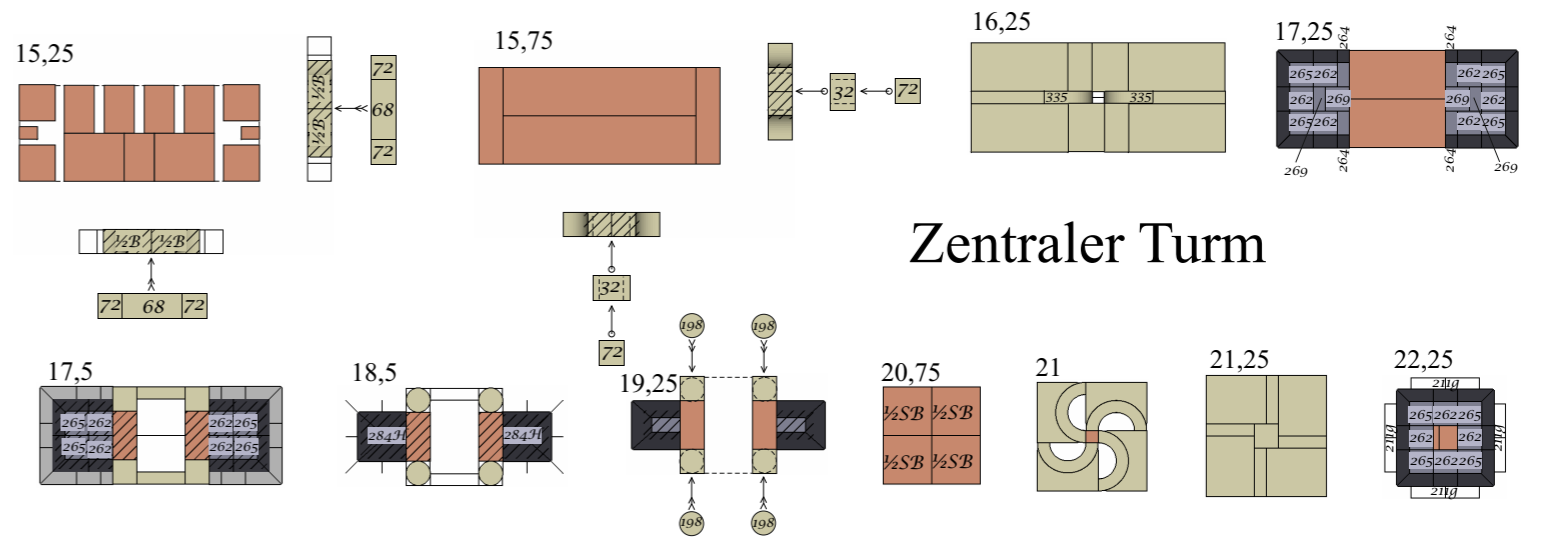

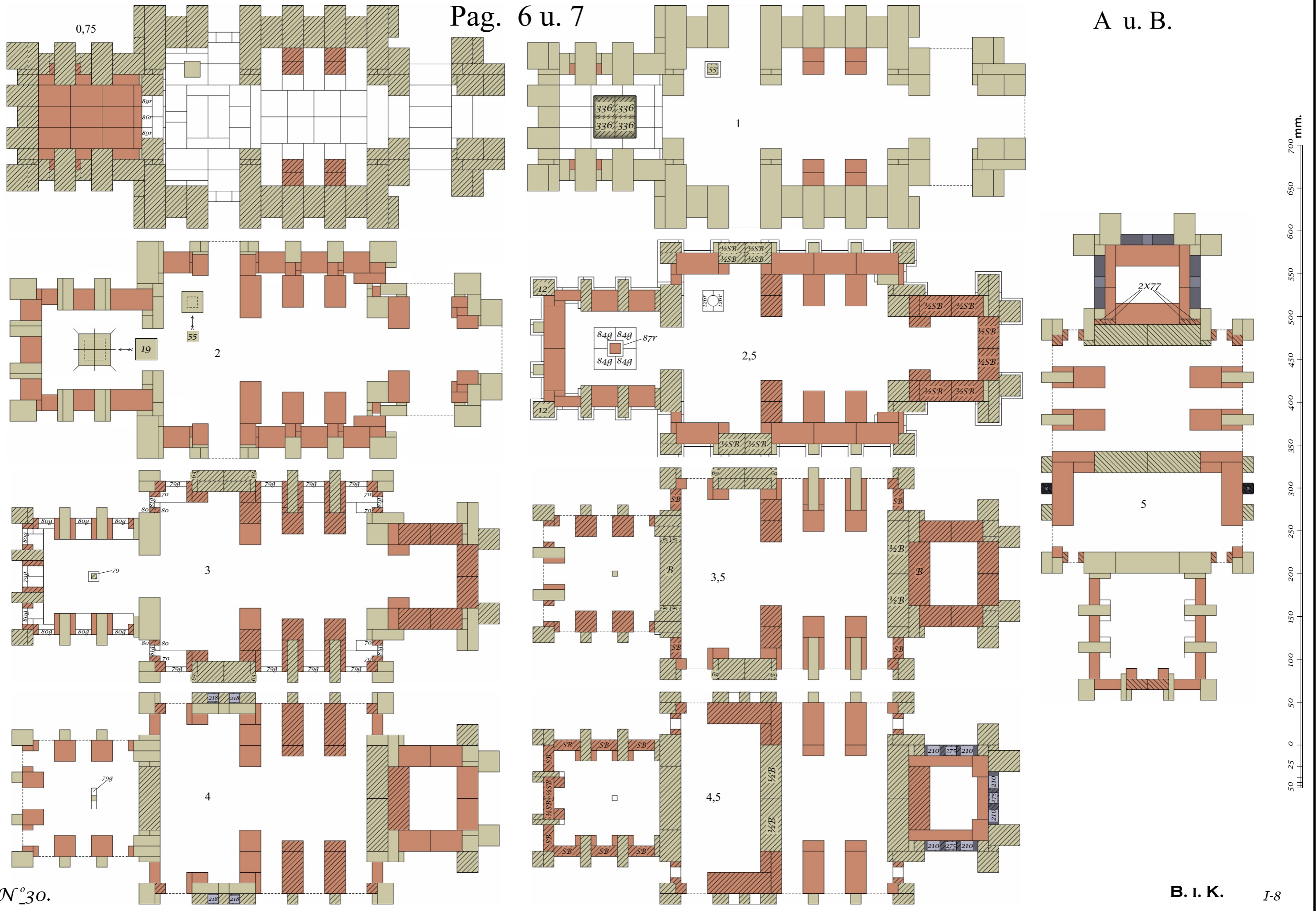

N^o 30.

B. I. K.

I-8

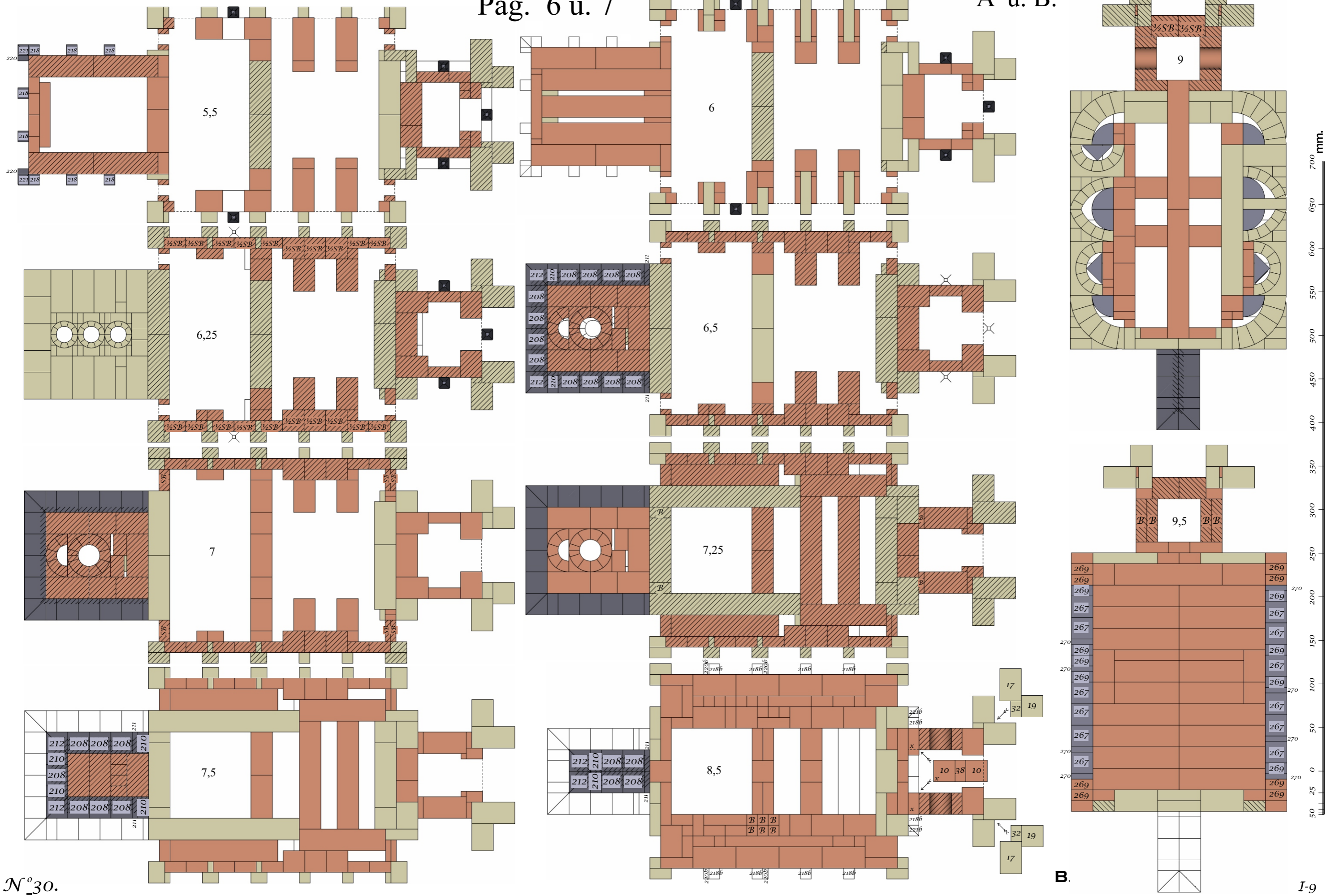

N°30.

I-9

Pag. 6 u. 7

A u. B.

Laternenpfahl

4,5

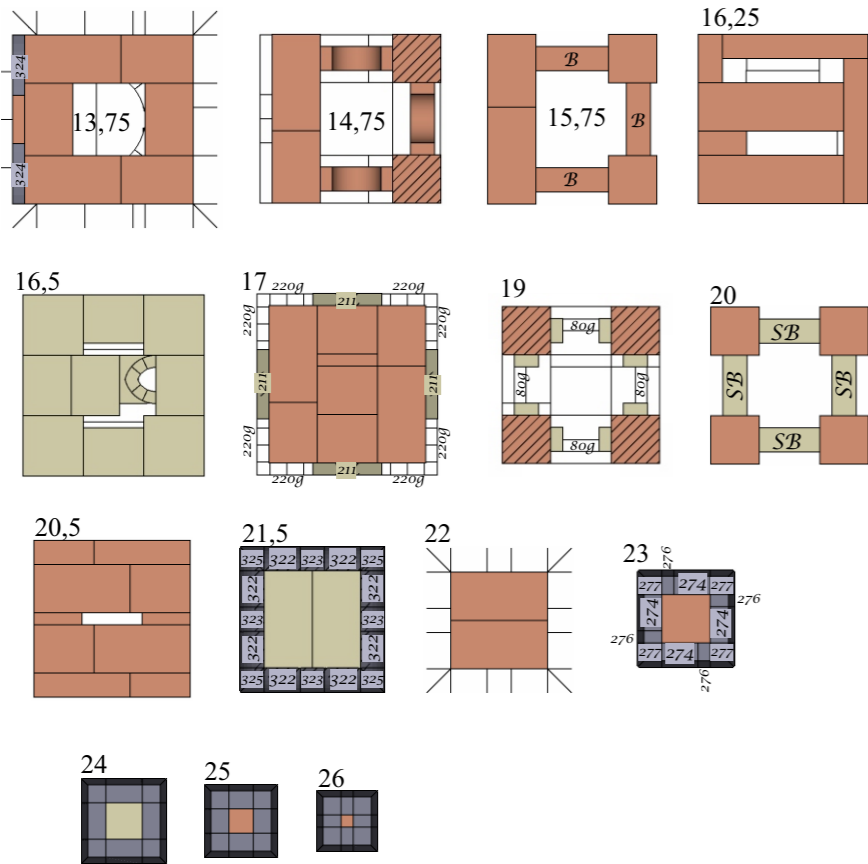
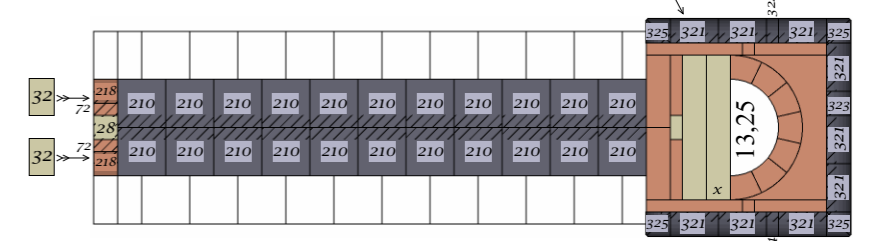
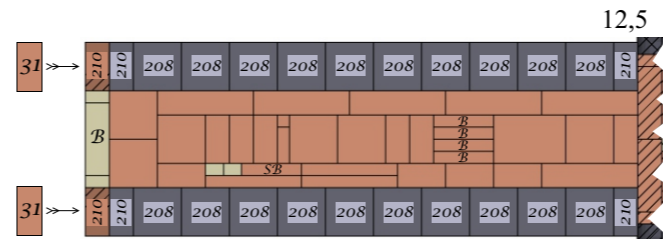
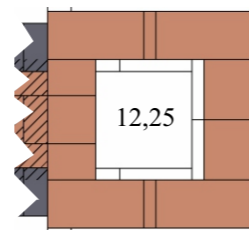
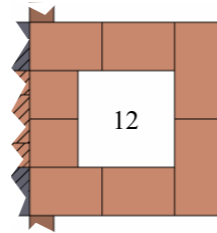
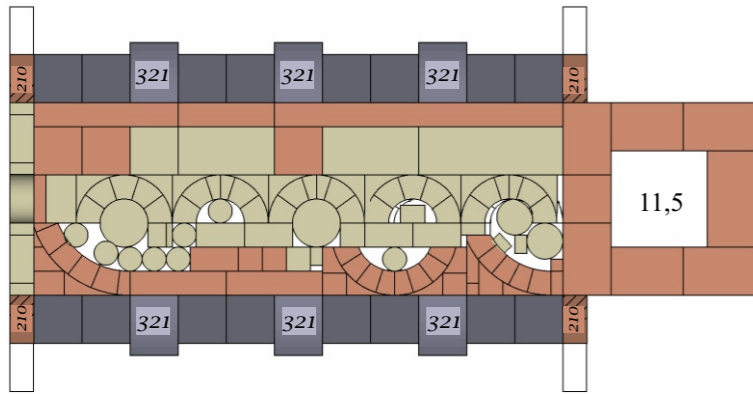
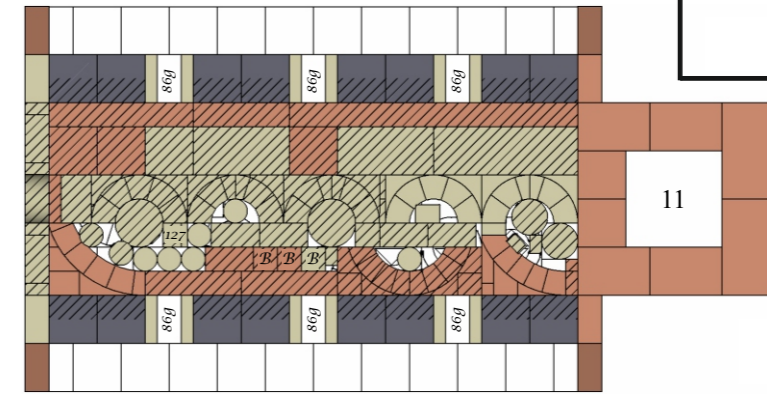
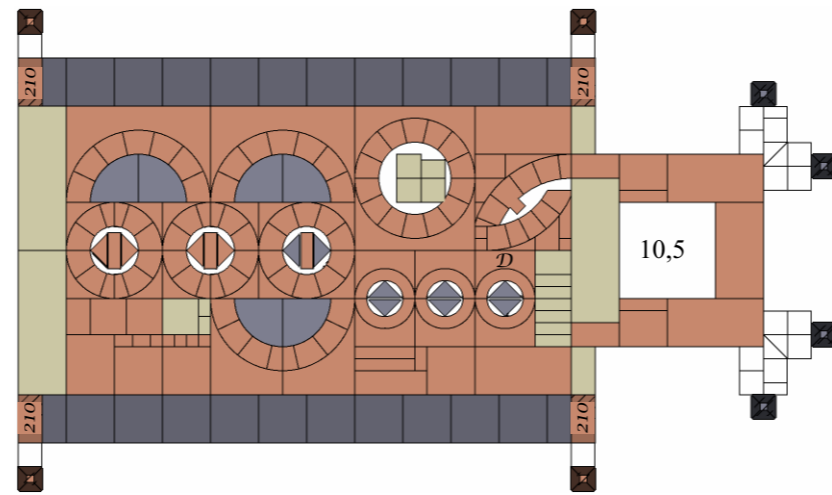
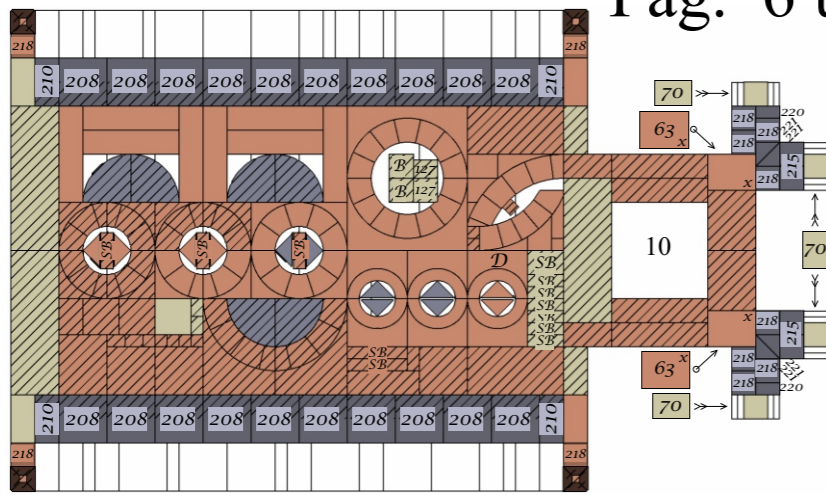

Pag. 10 u. 11

A u. B.

0,25

0,5

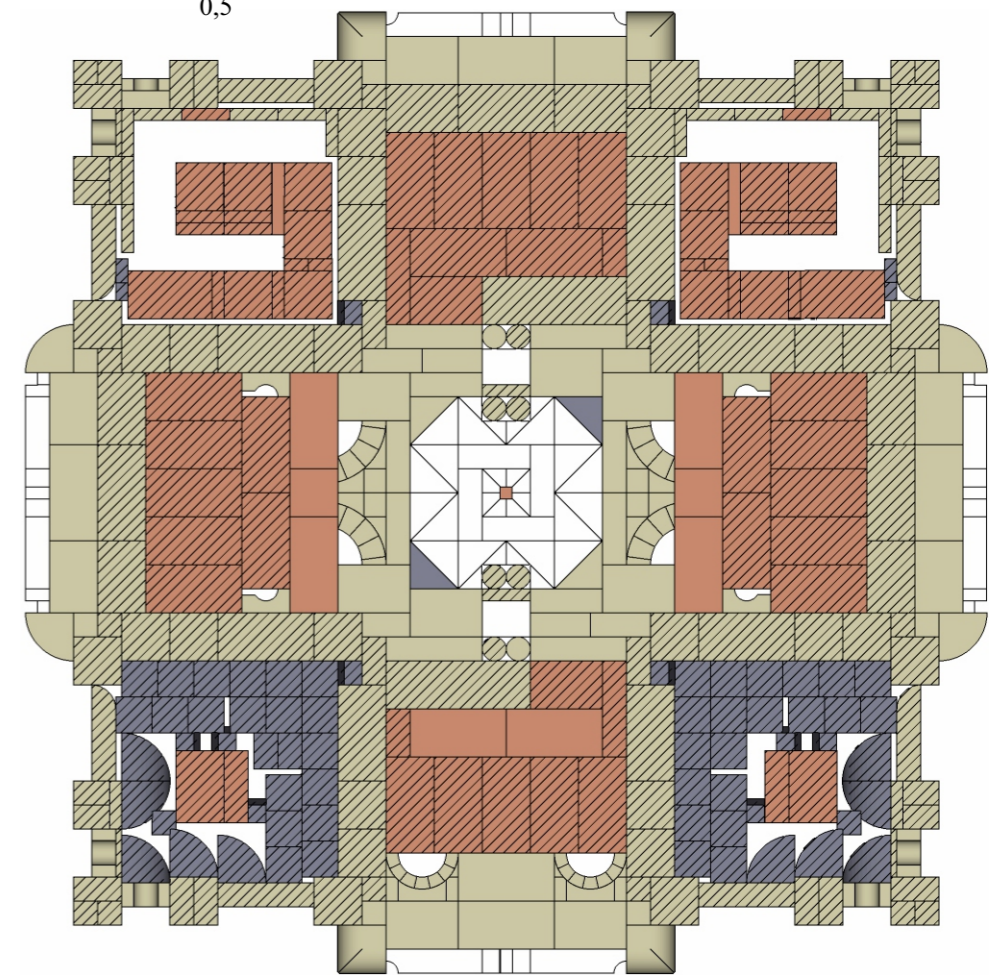
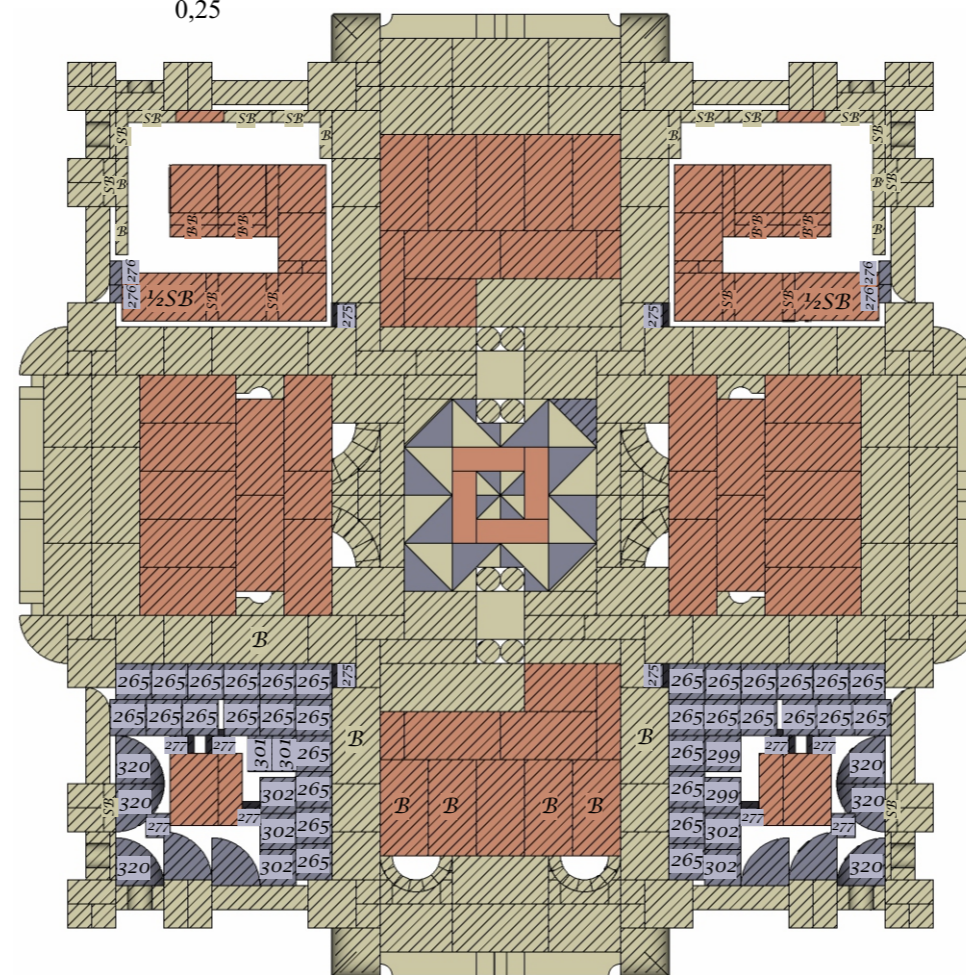

50 25 0 50 100 150 200 250 300 350 400 450 500 550 600 650 700 mm.

B. I. K.

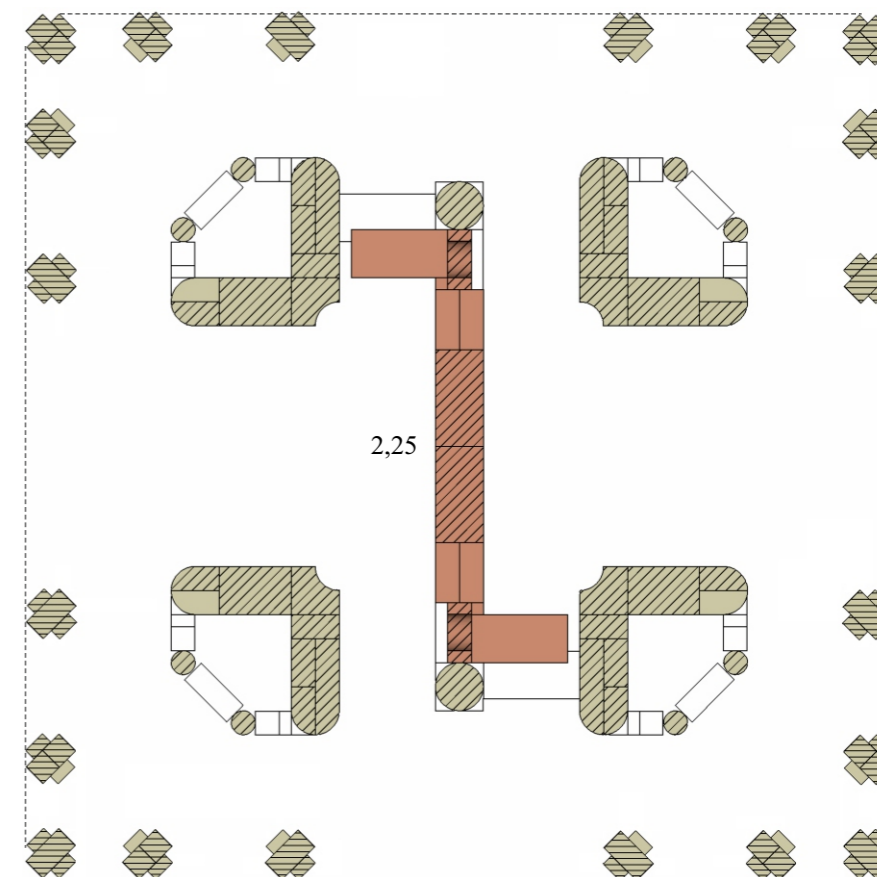
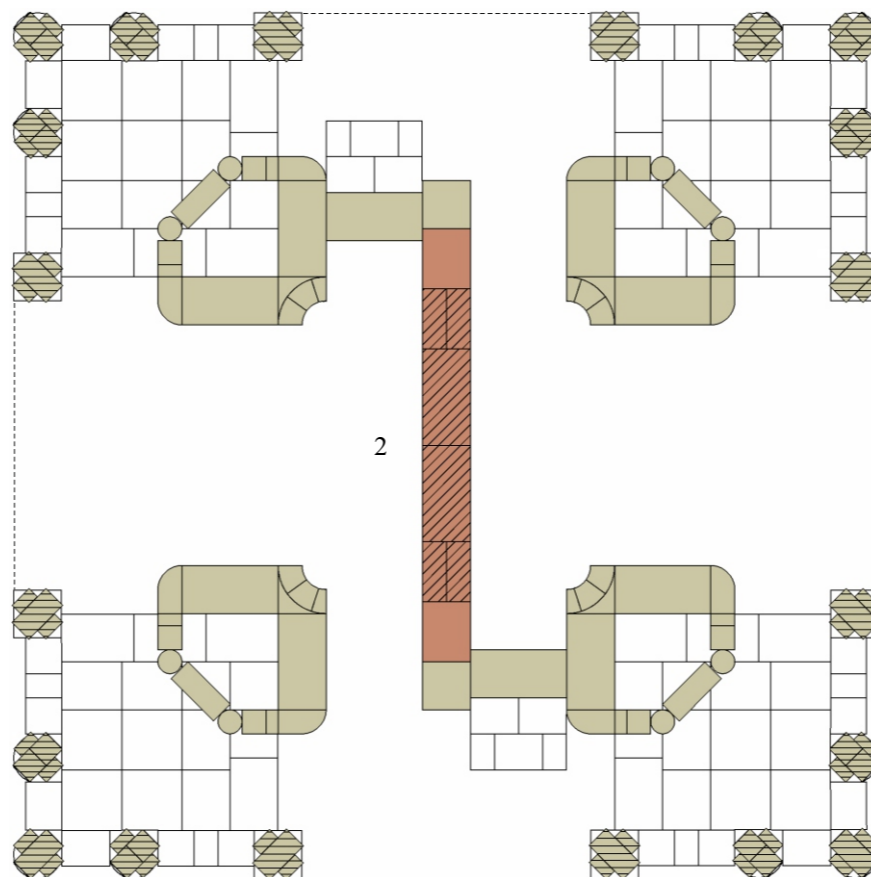
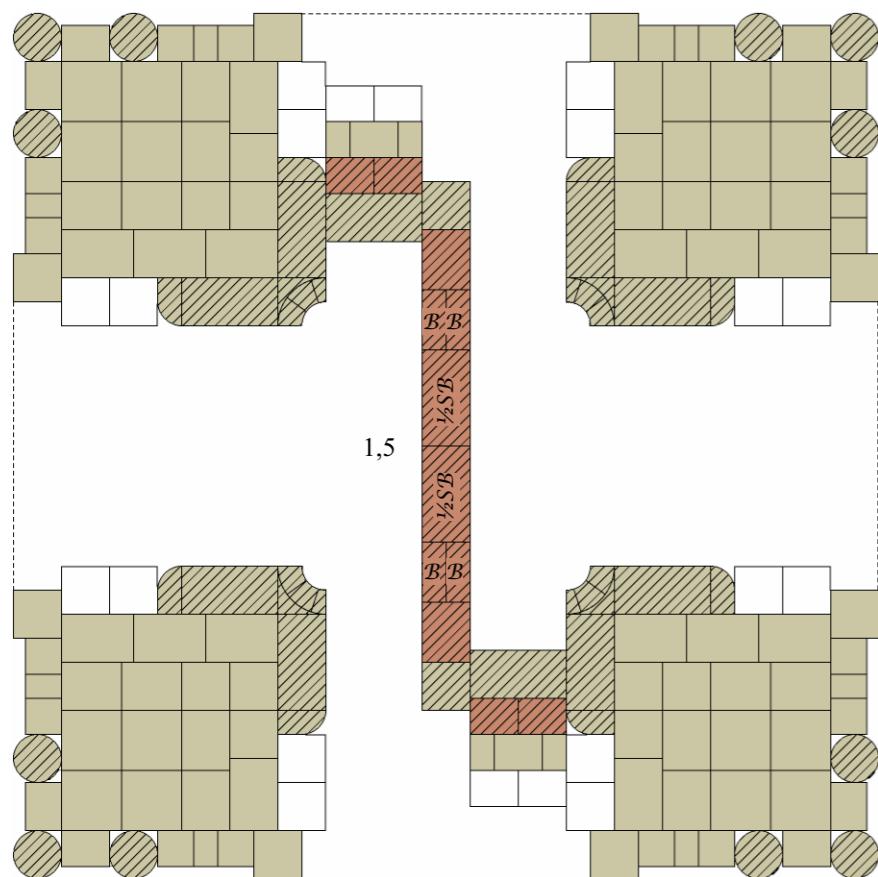
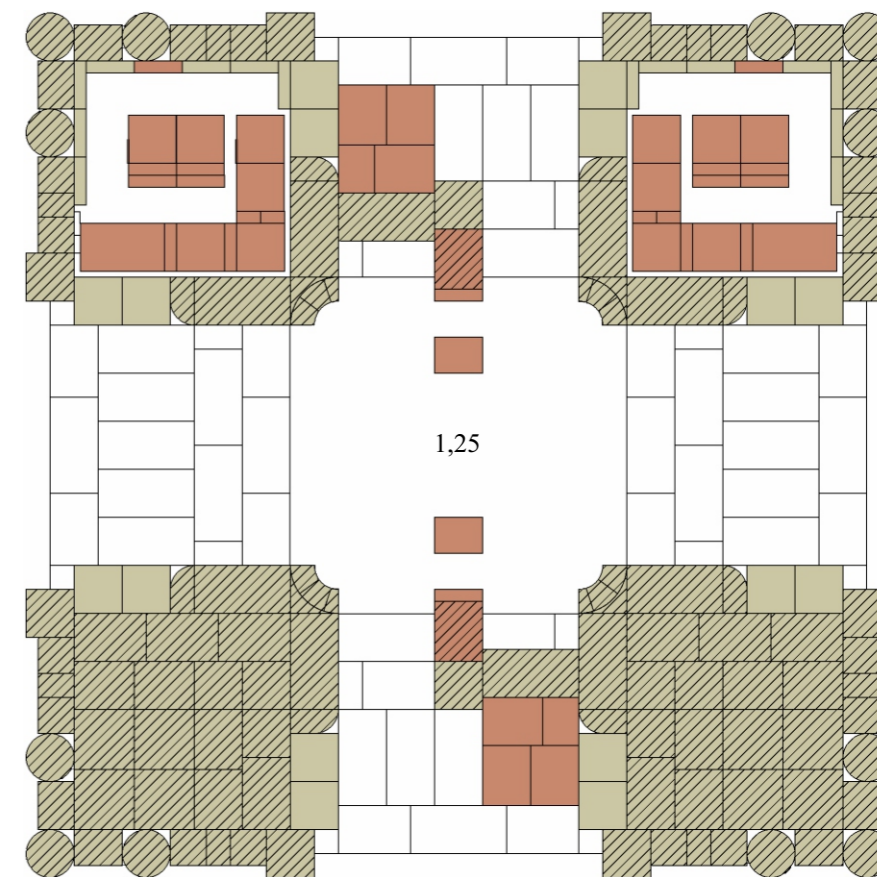
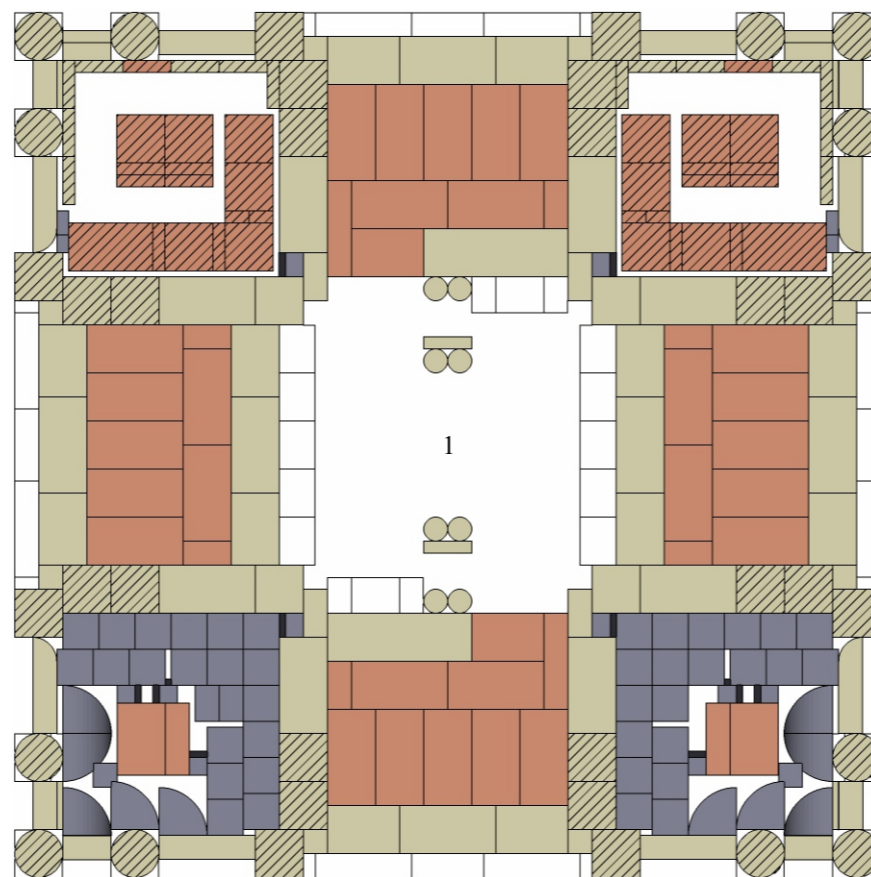
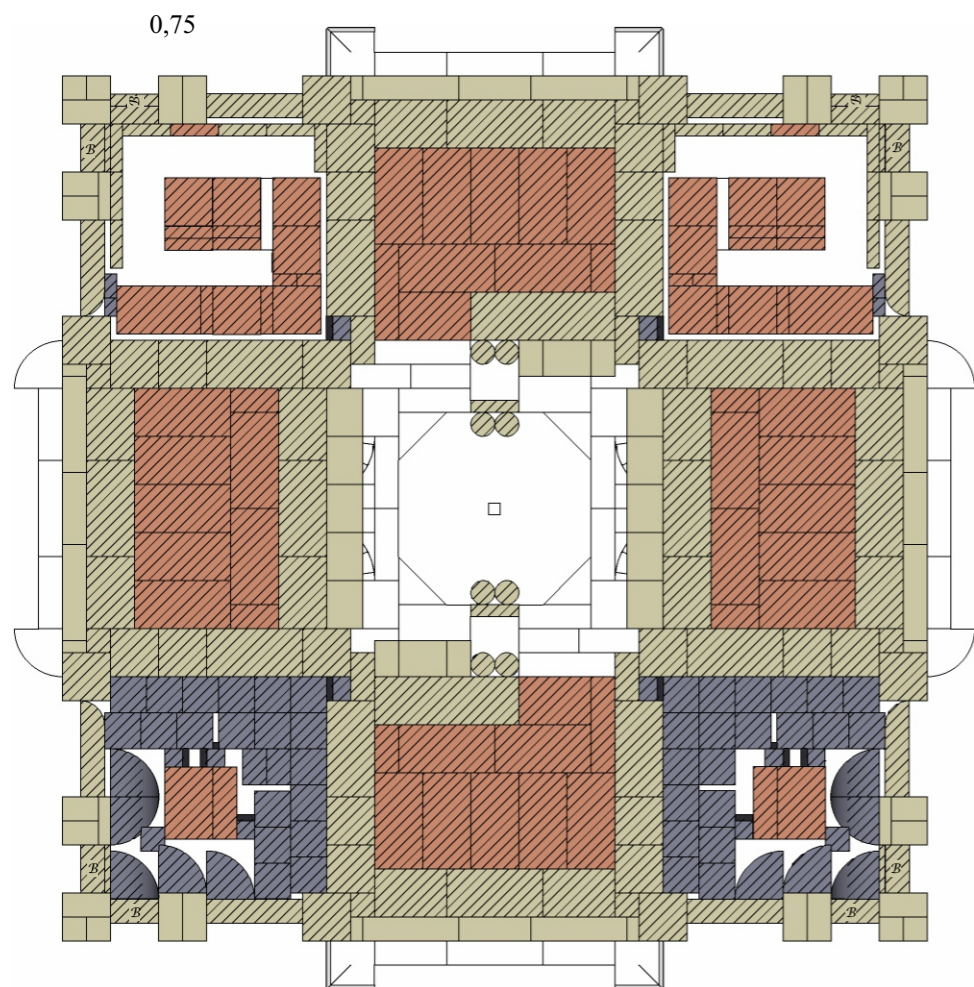

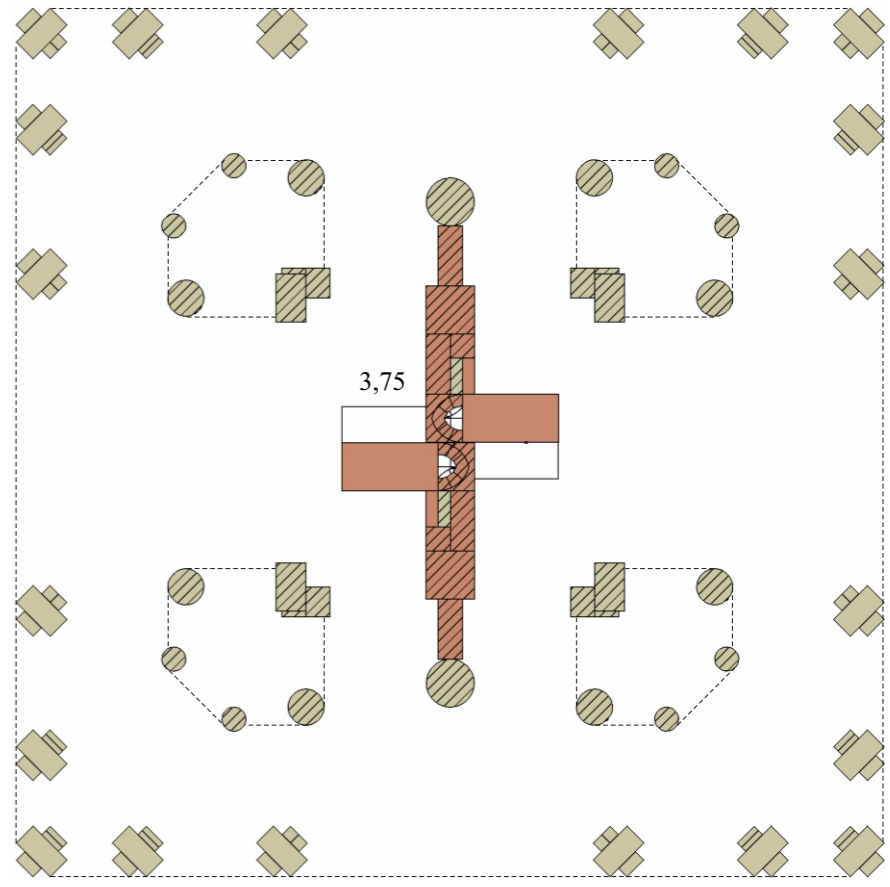
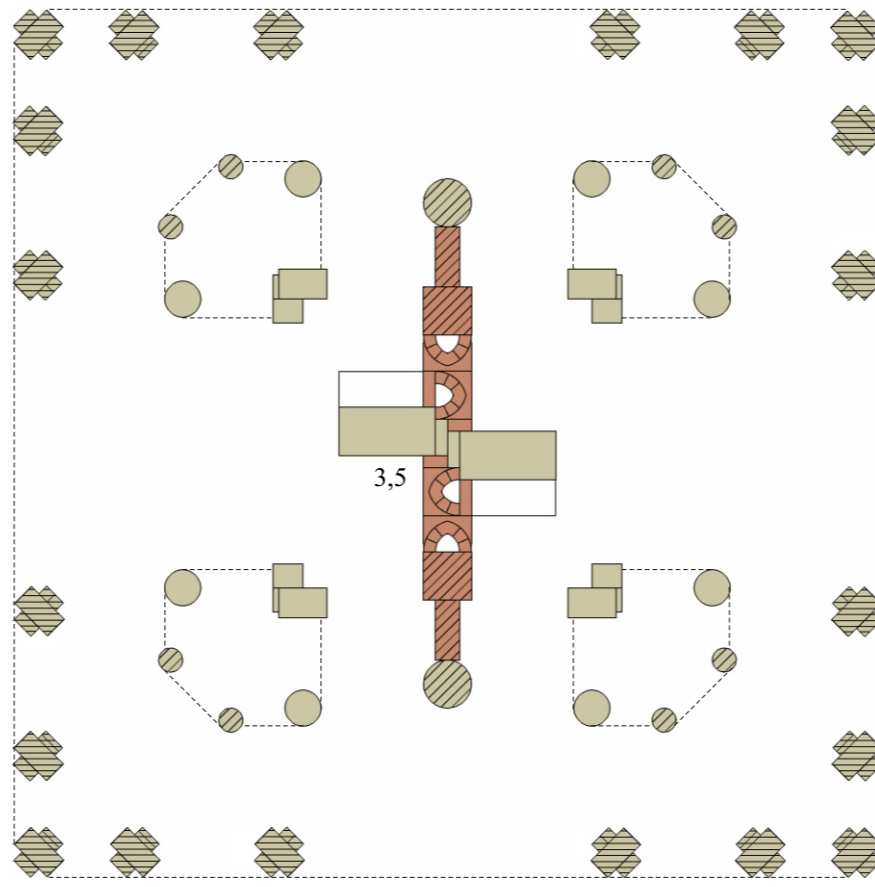
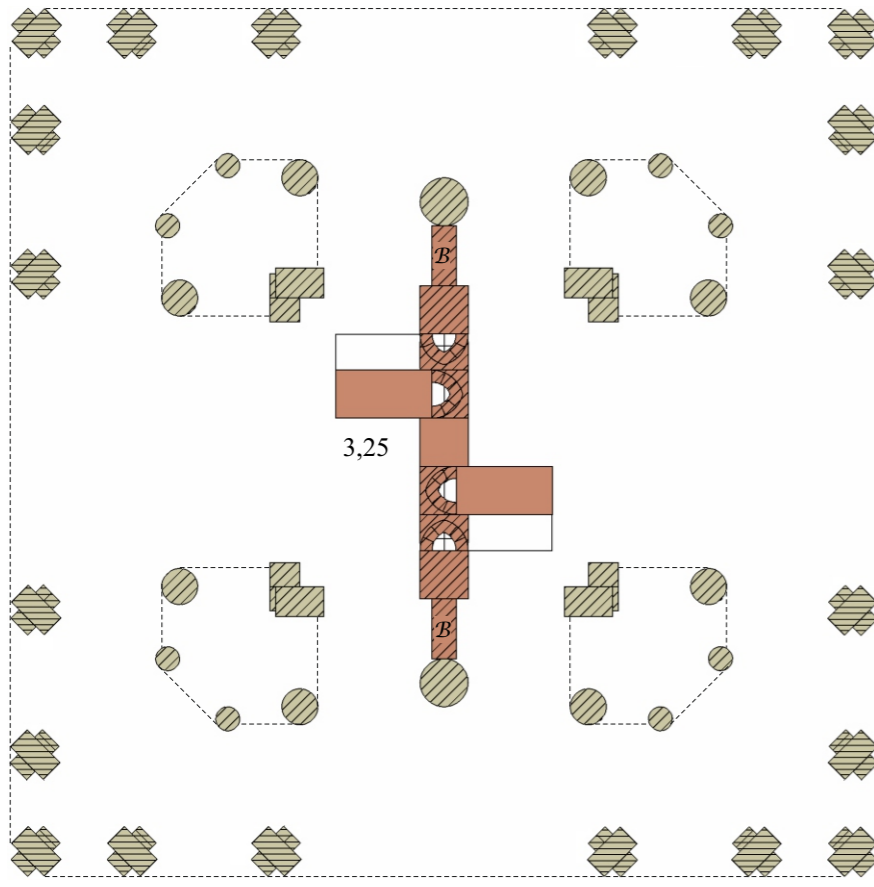
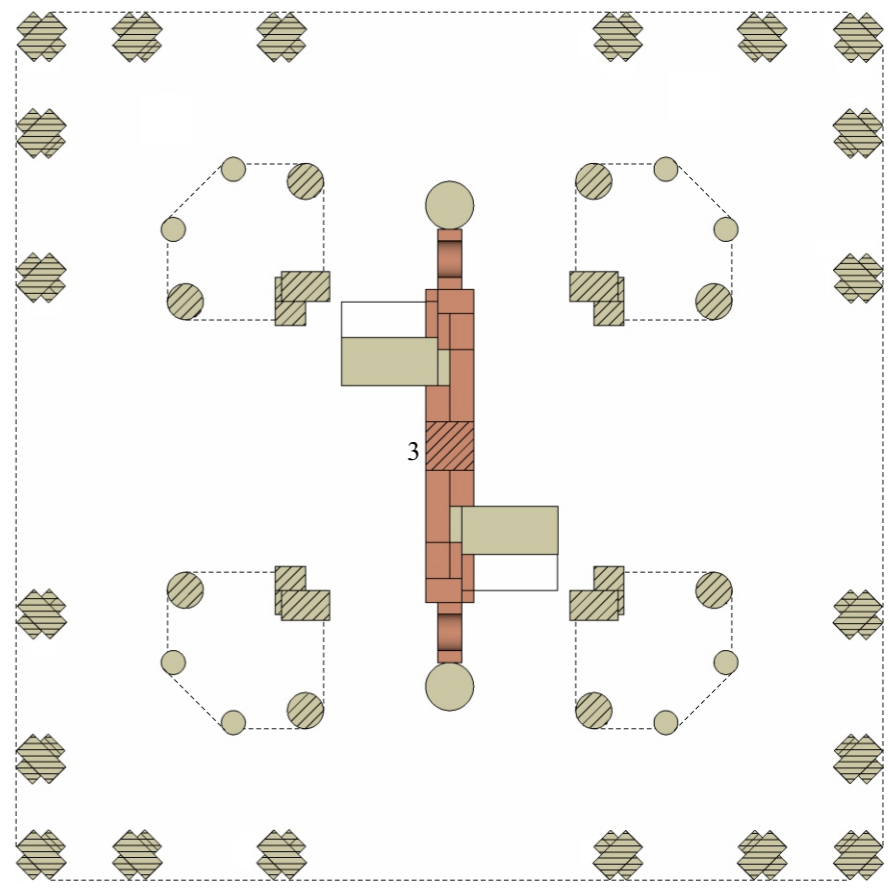
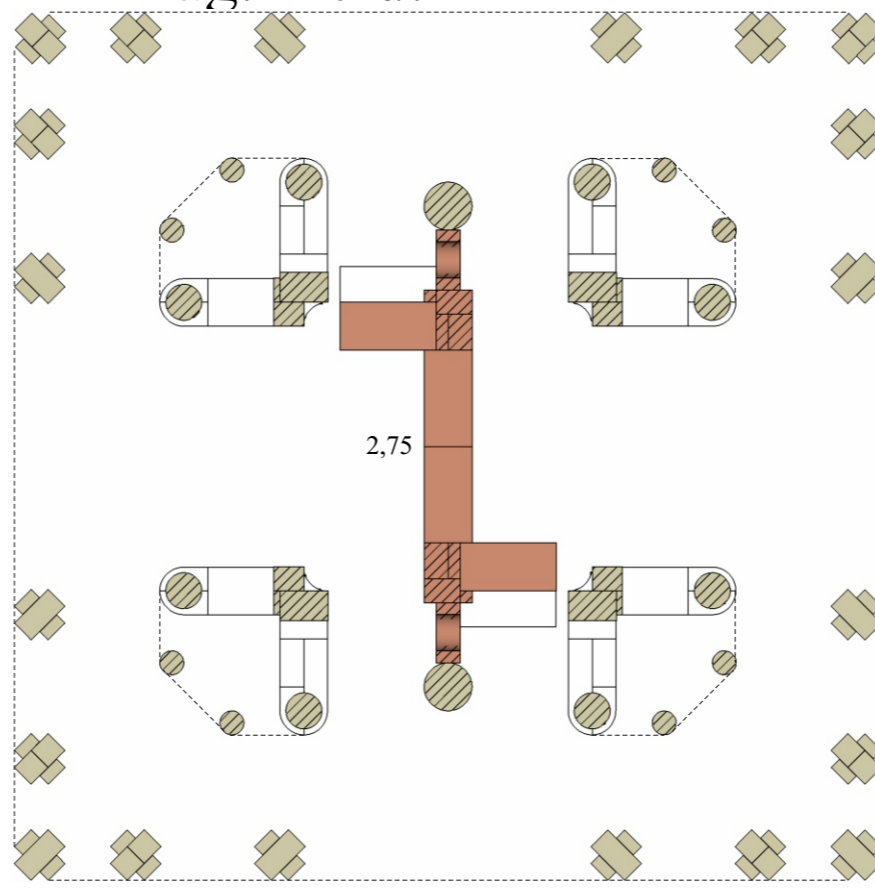
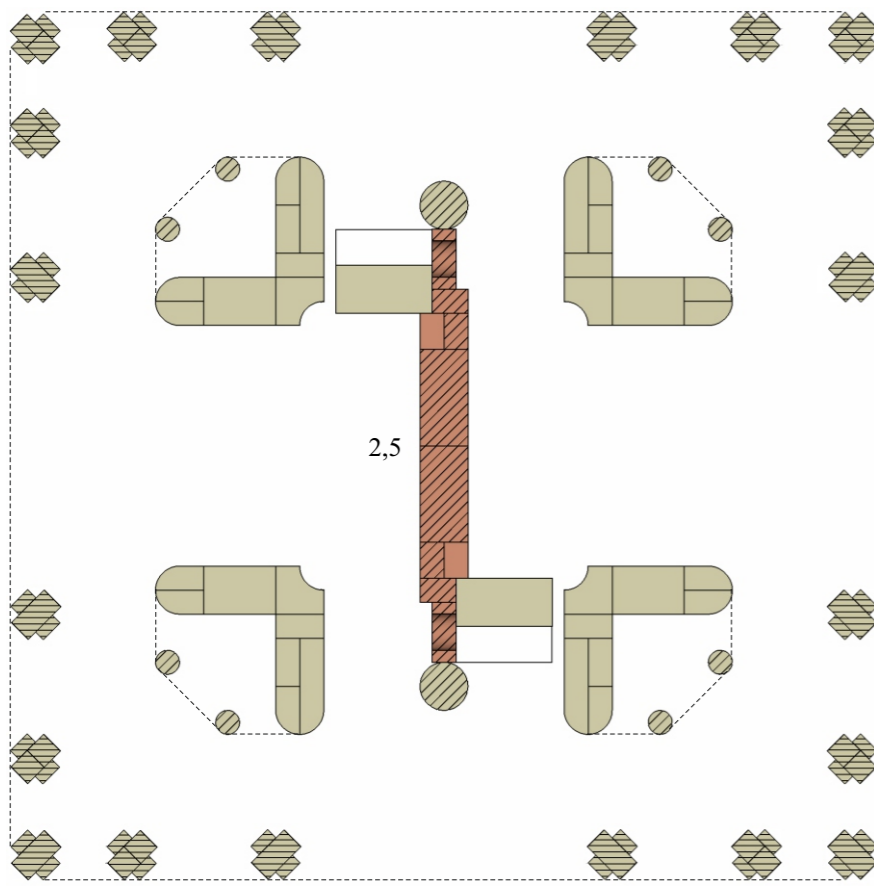

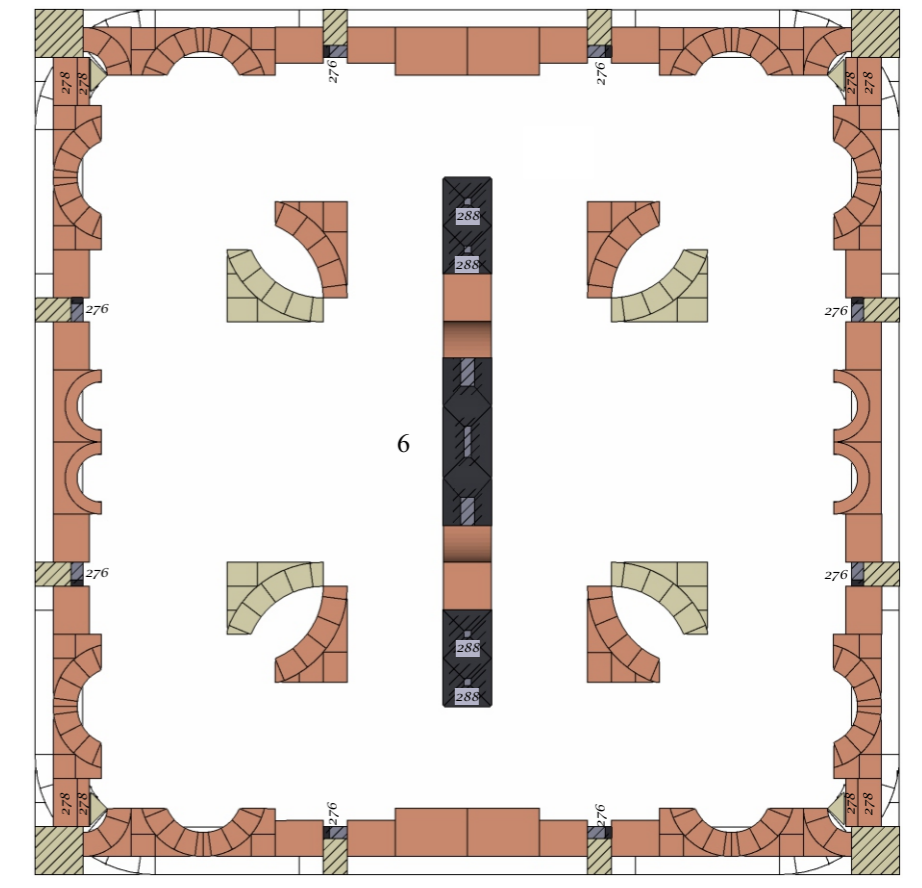
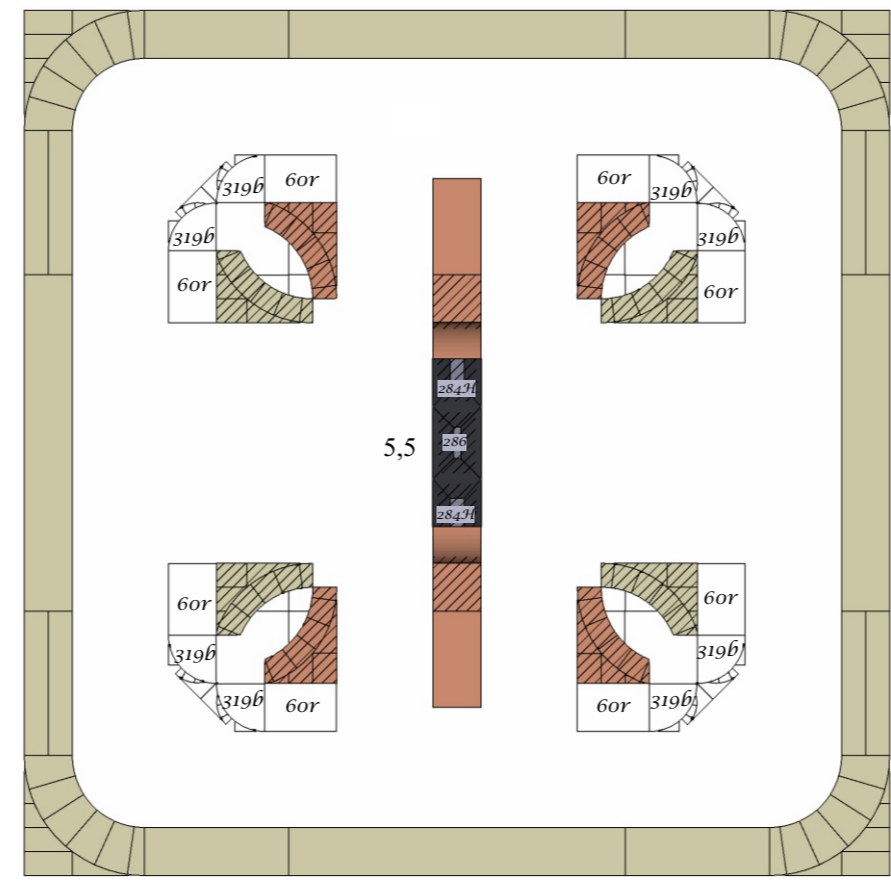
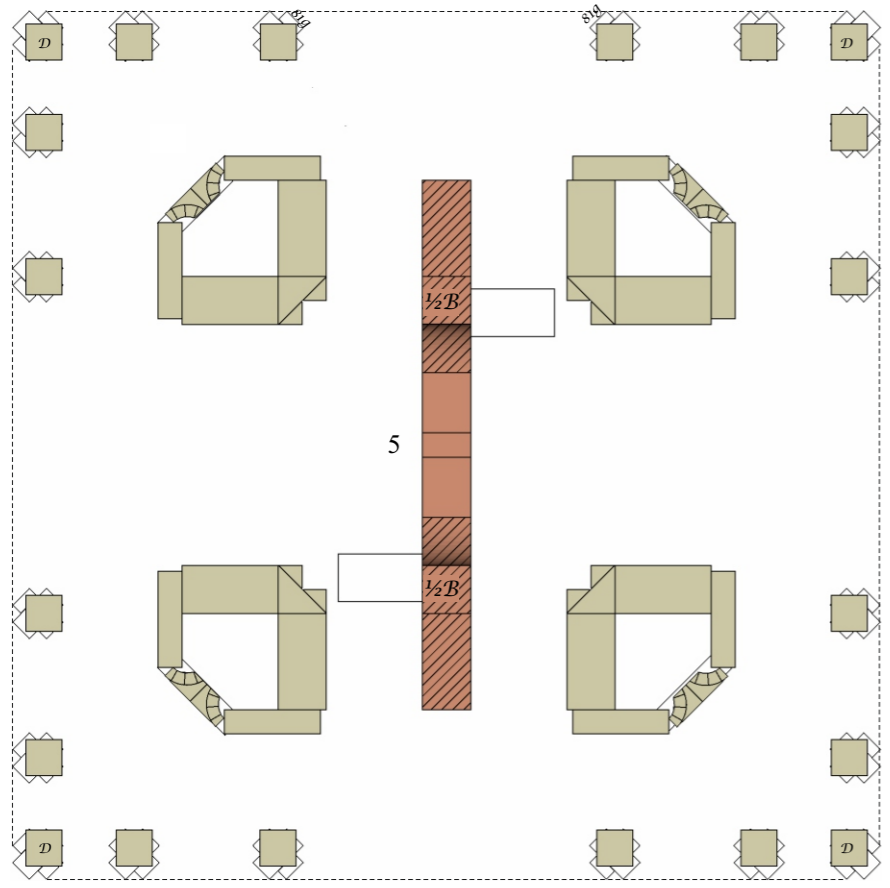
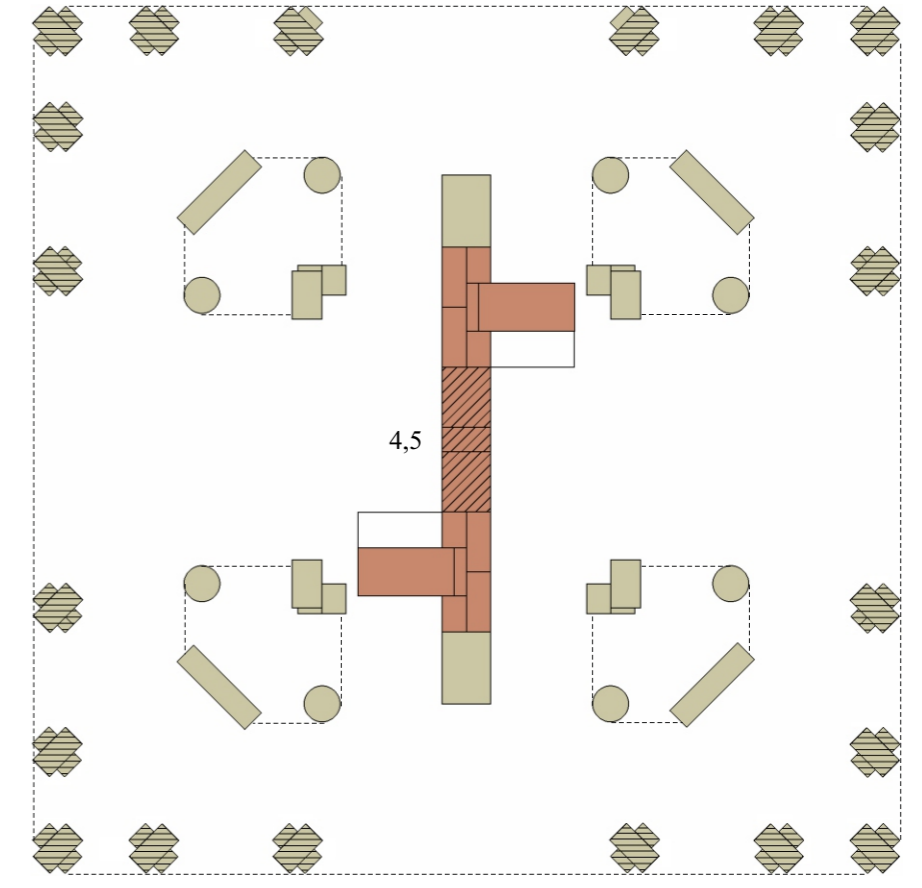
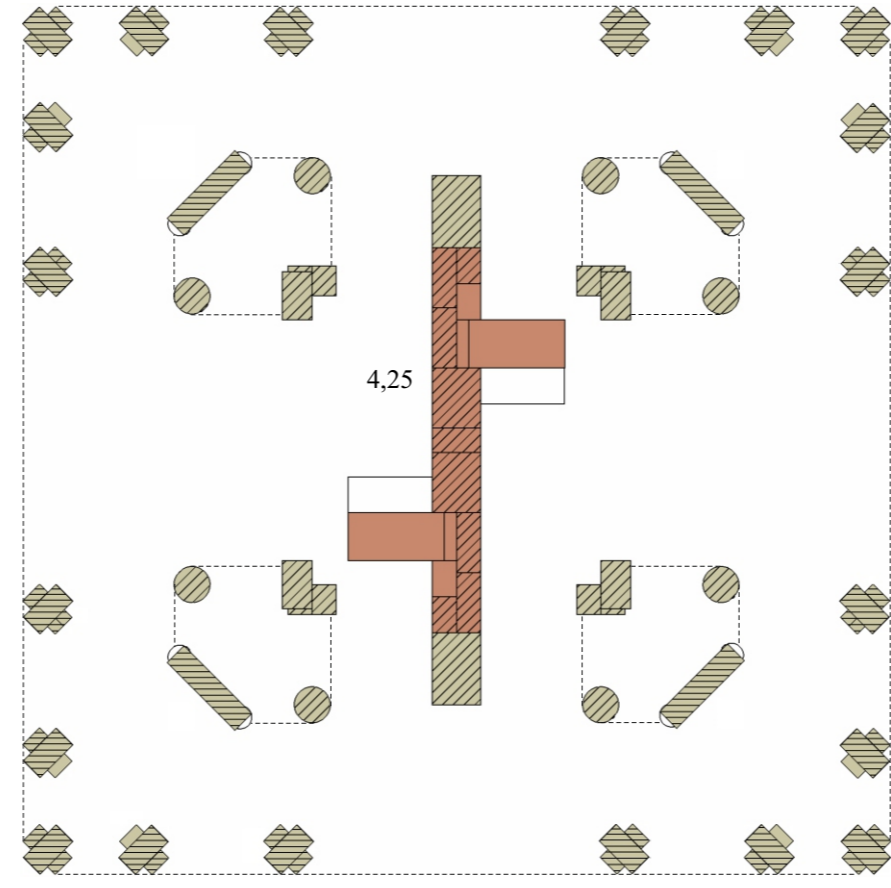
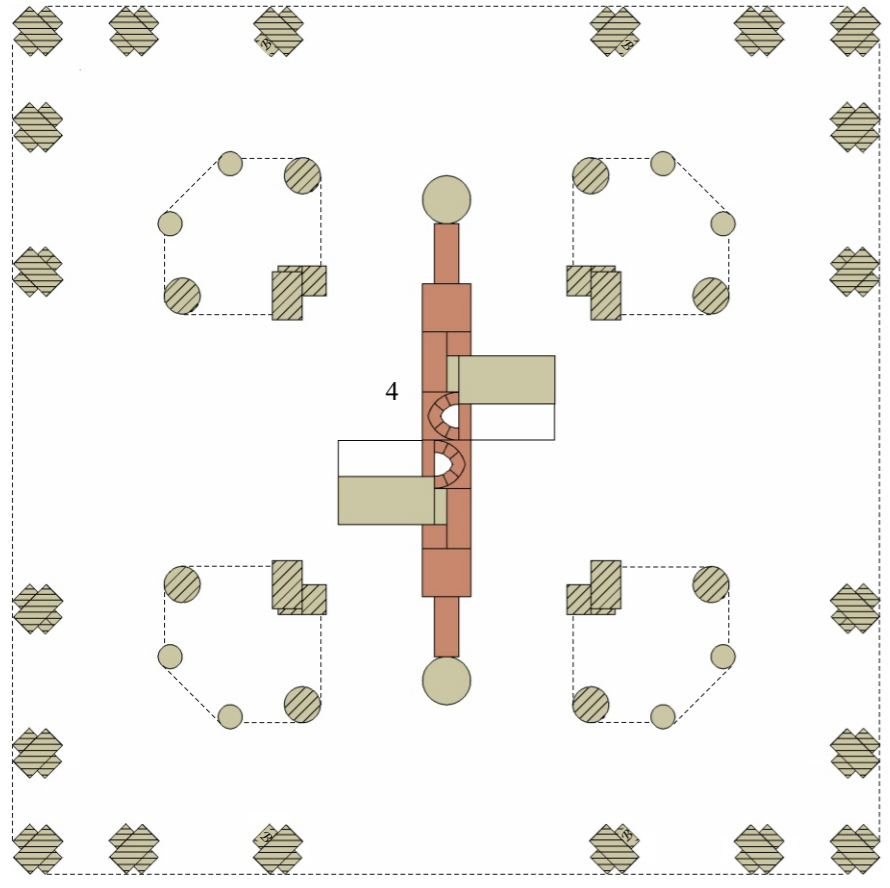

N^o 30.

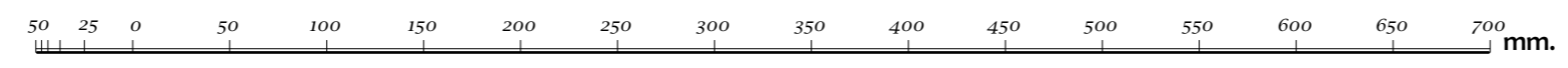

B. I. K.

I-13

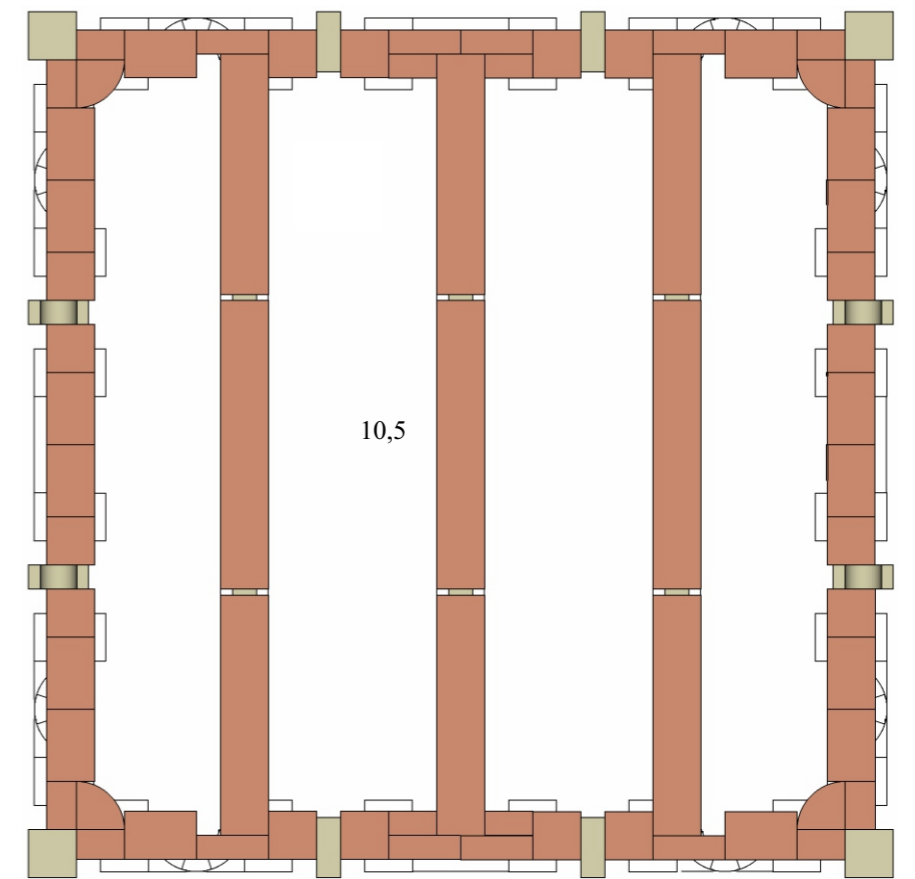
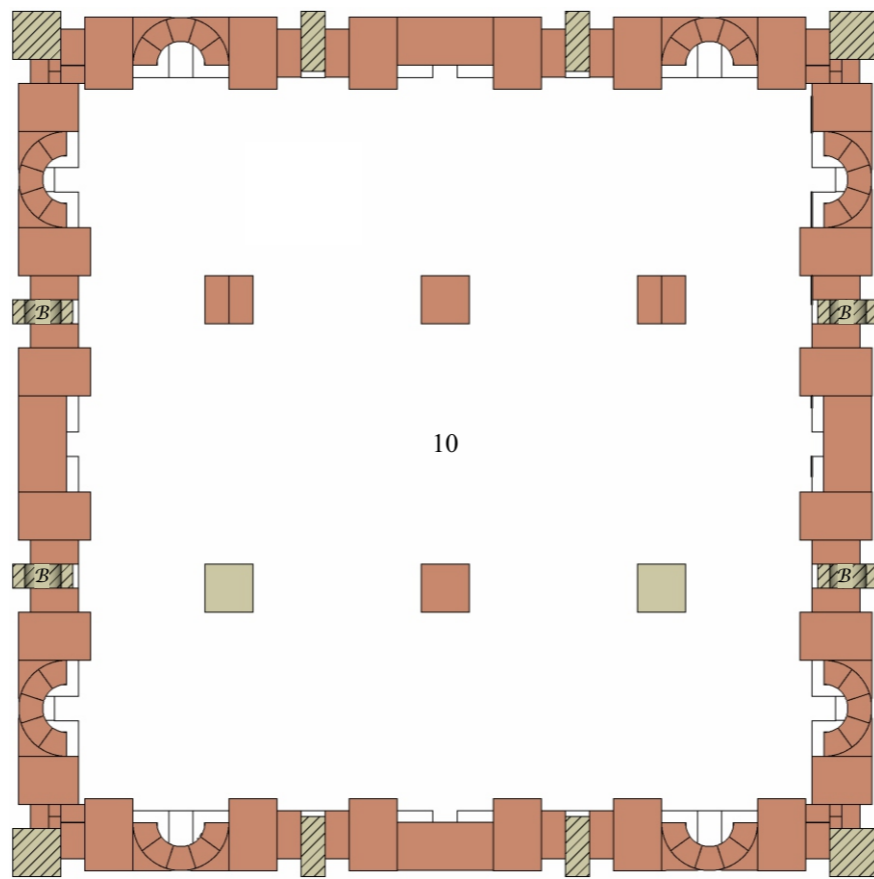
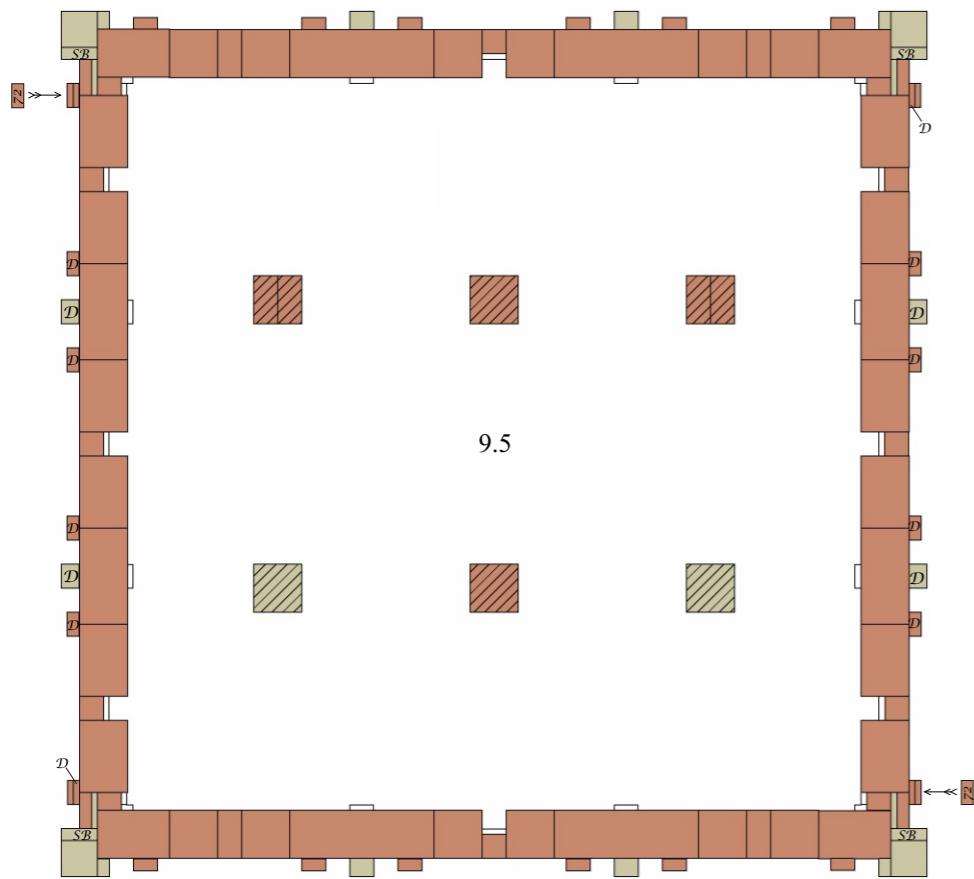
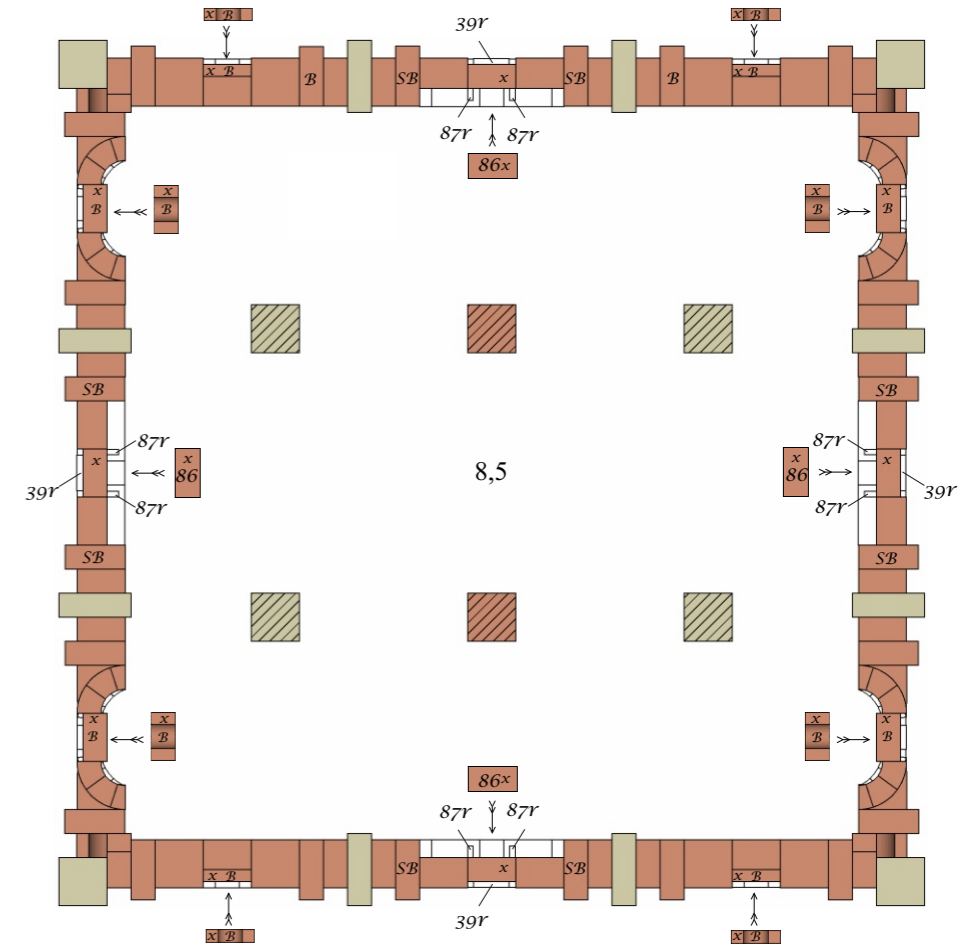
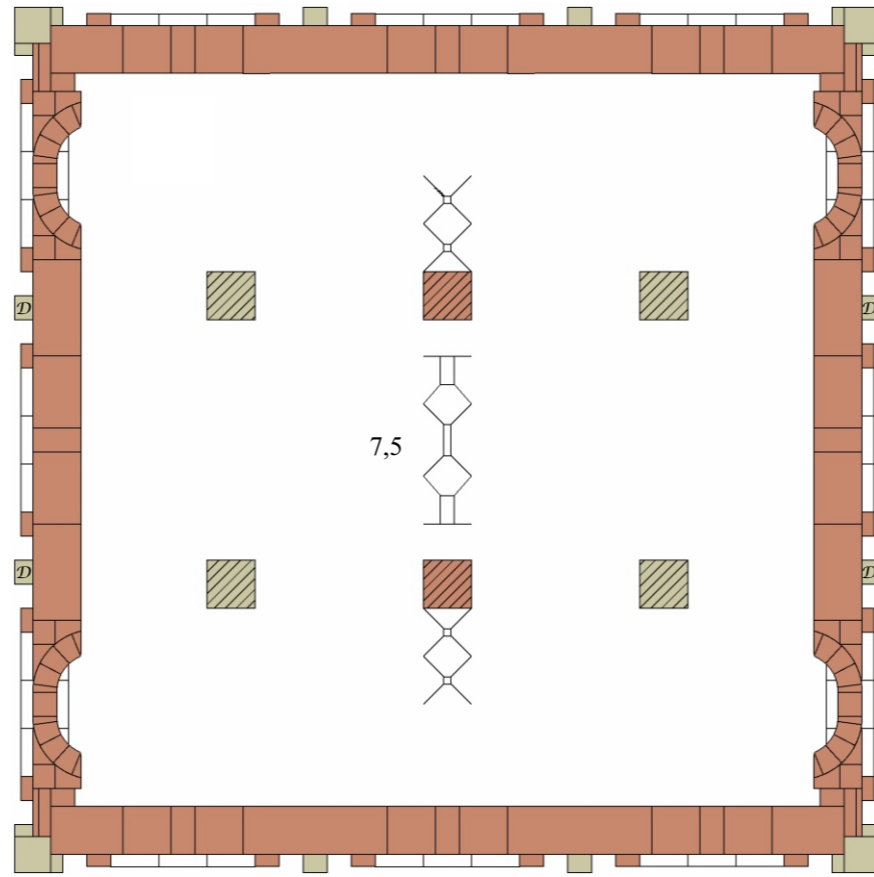
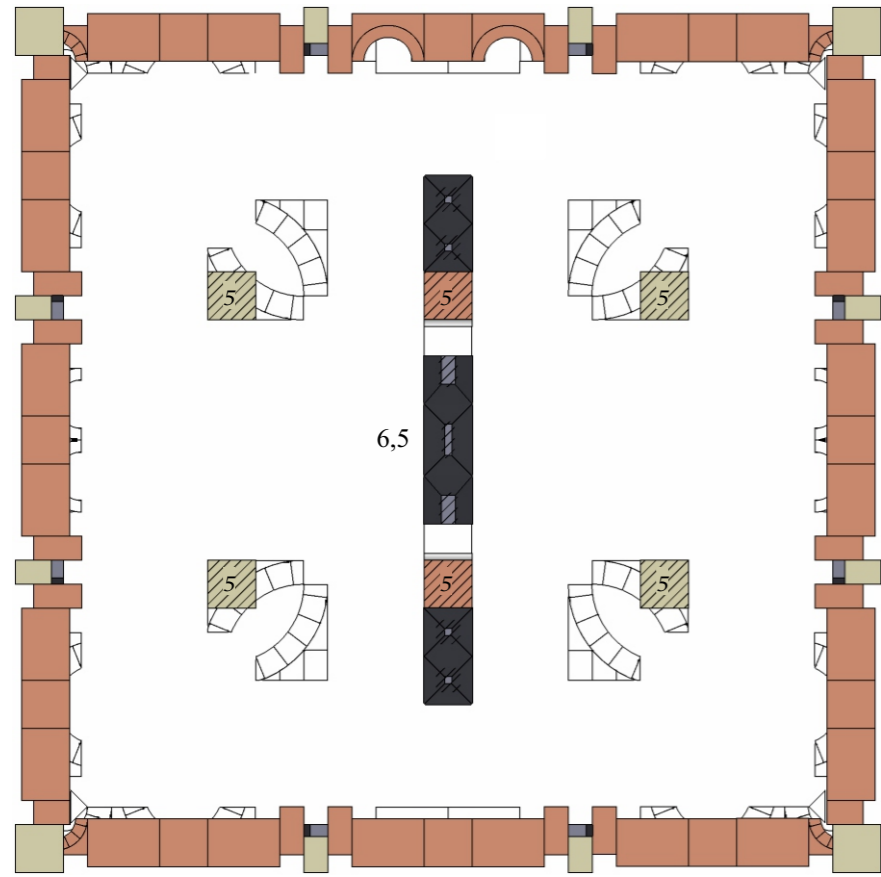

N^o 30.

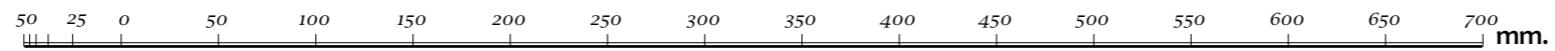

B. I. K.

I-14

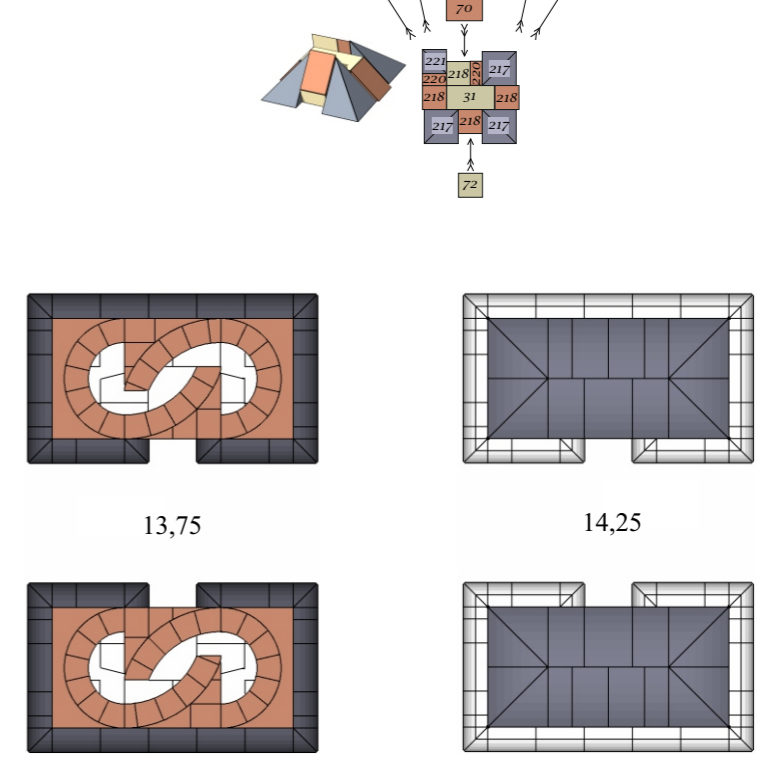
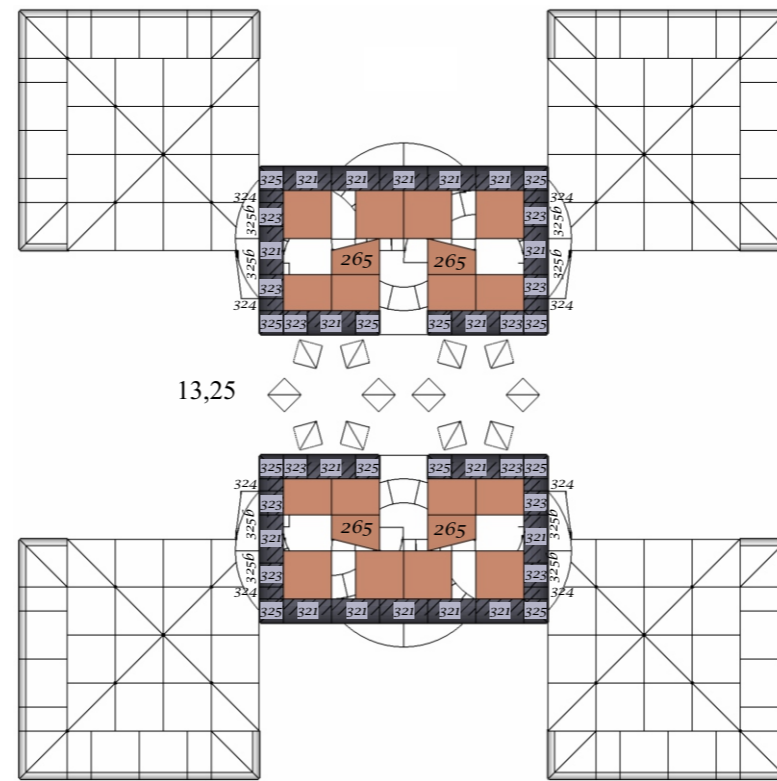
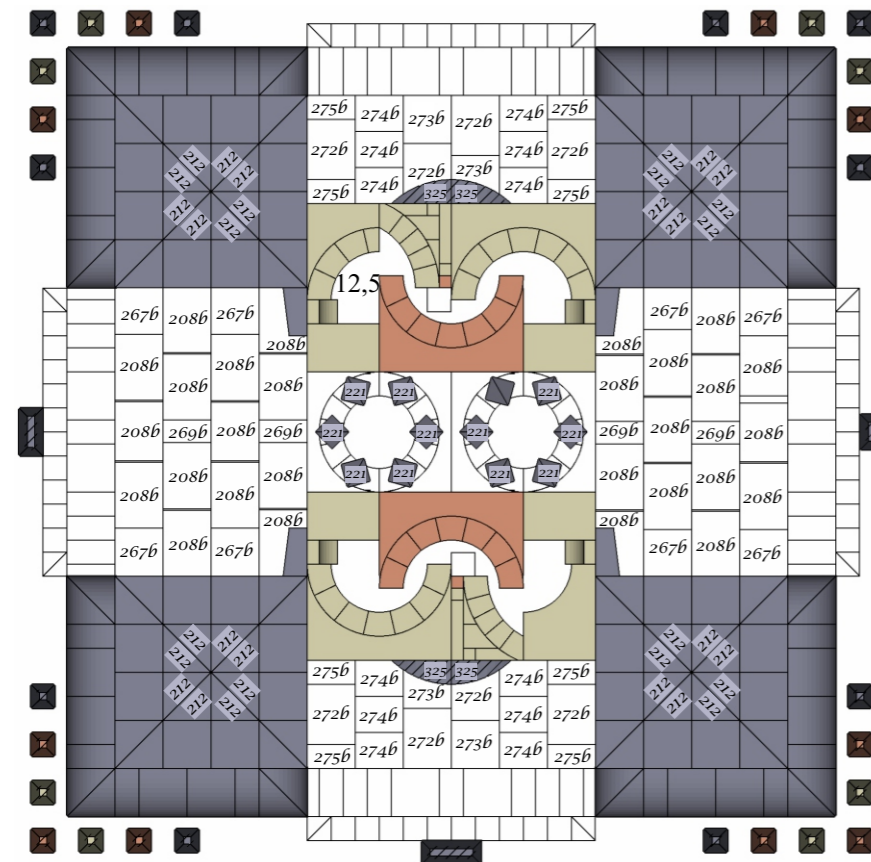
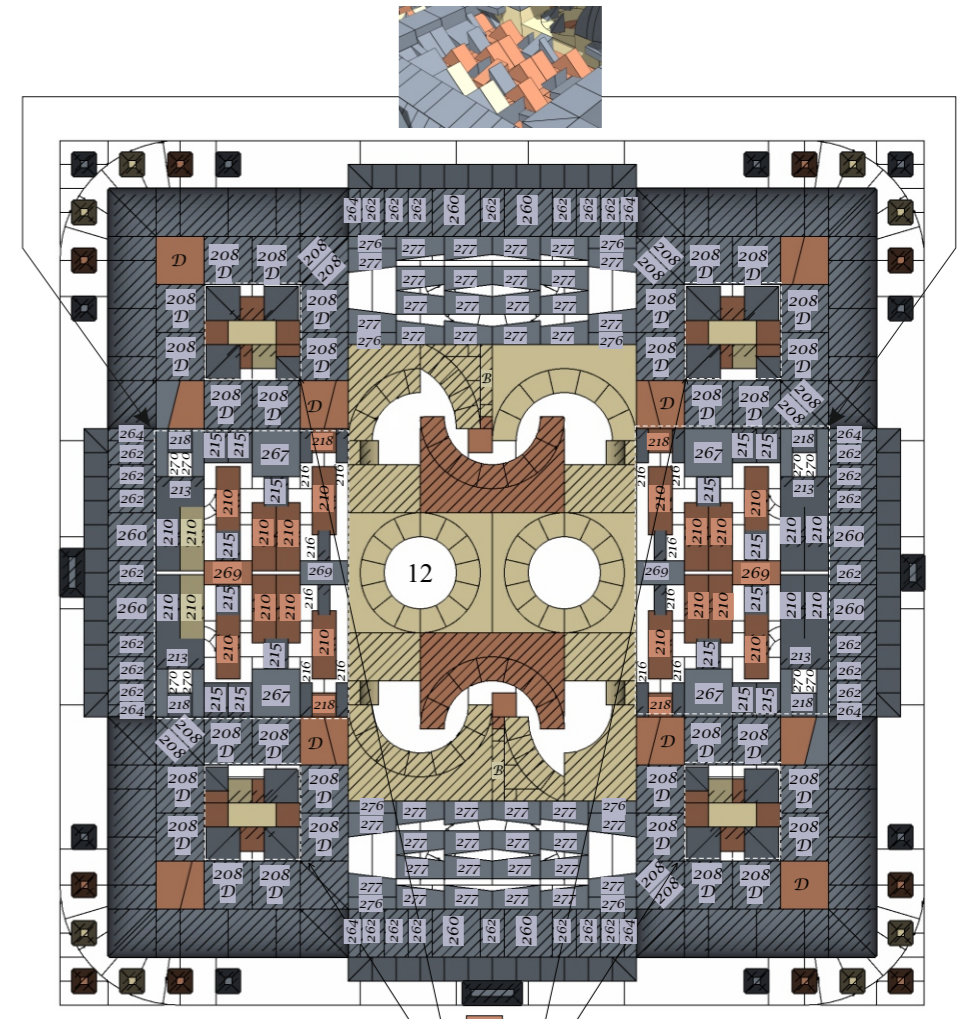
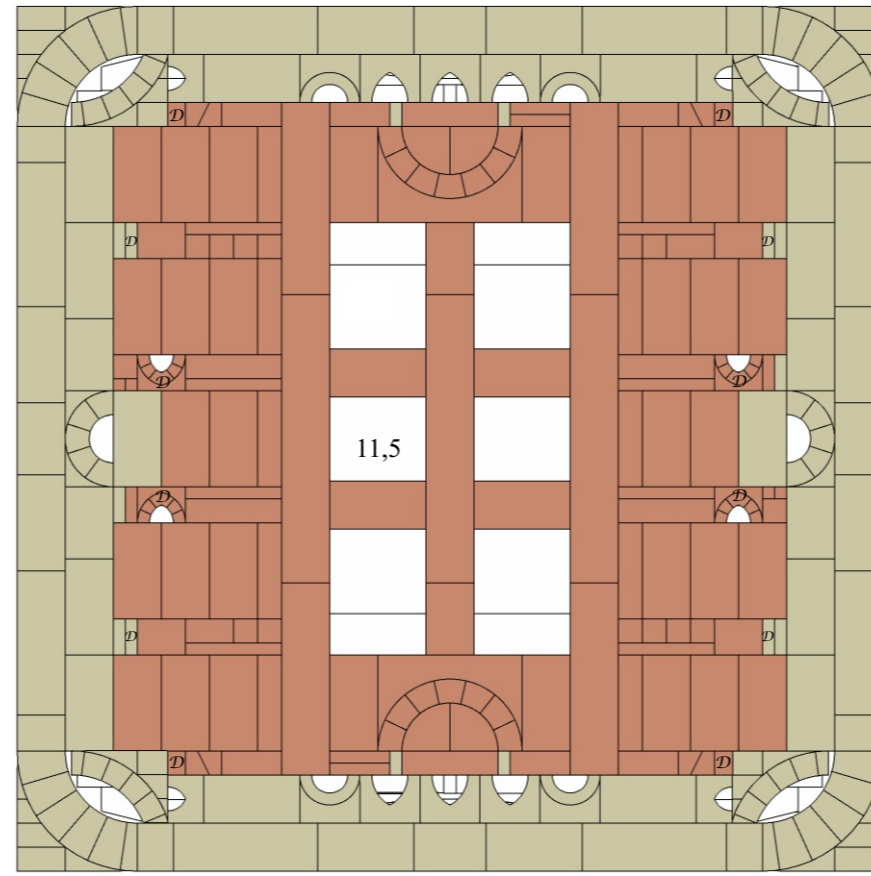
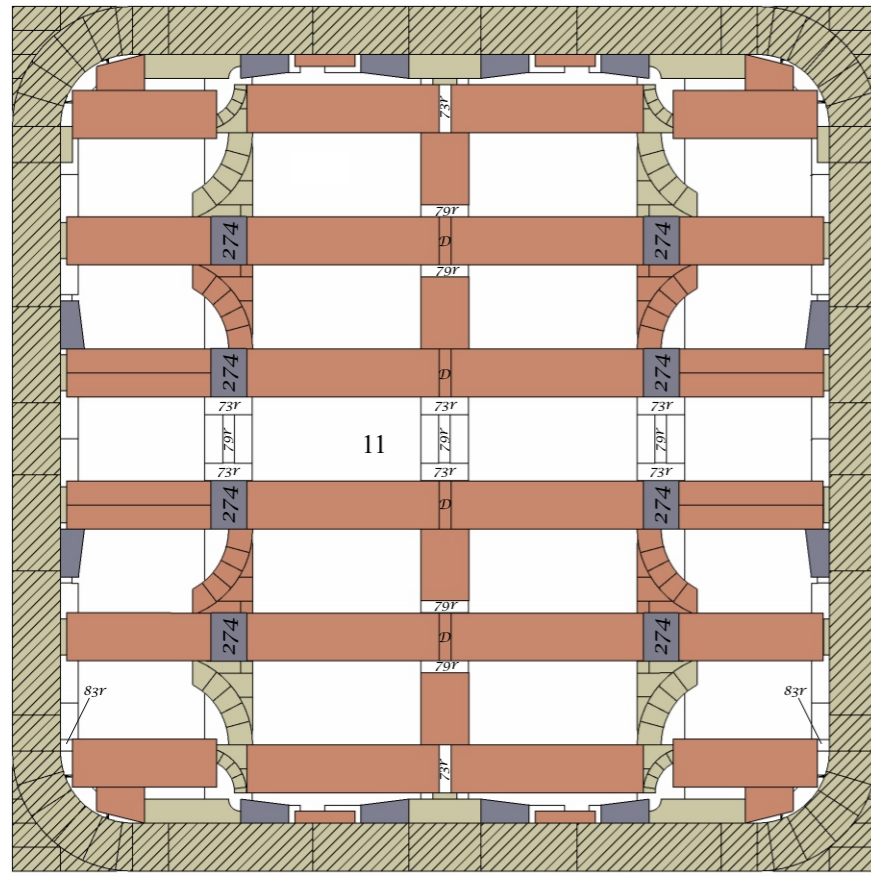

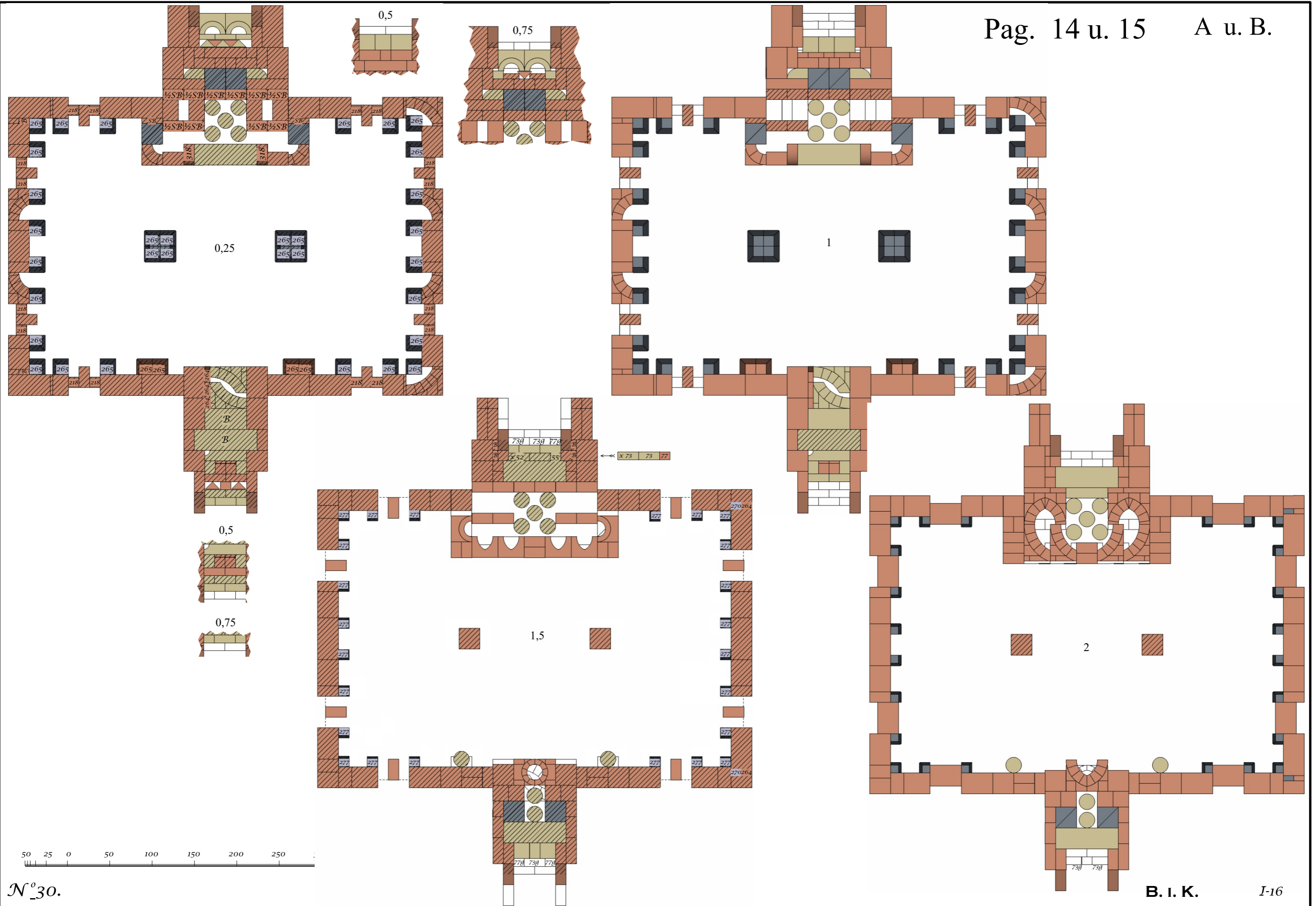

N^o 30.

B. I. K.

I-16

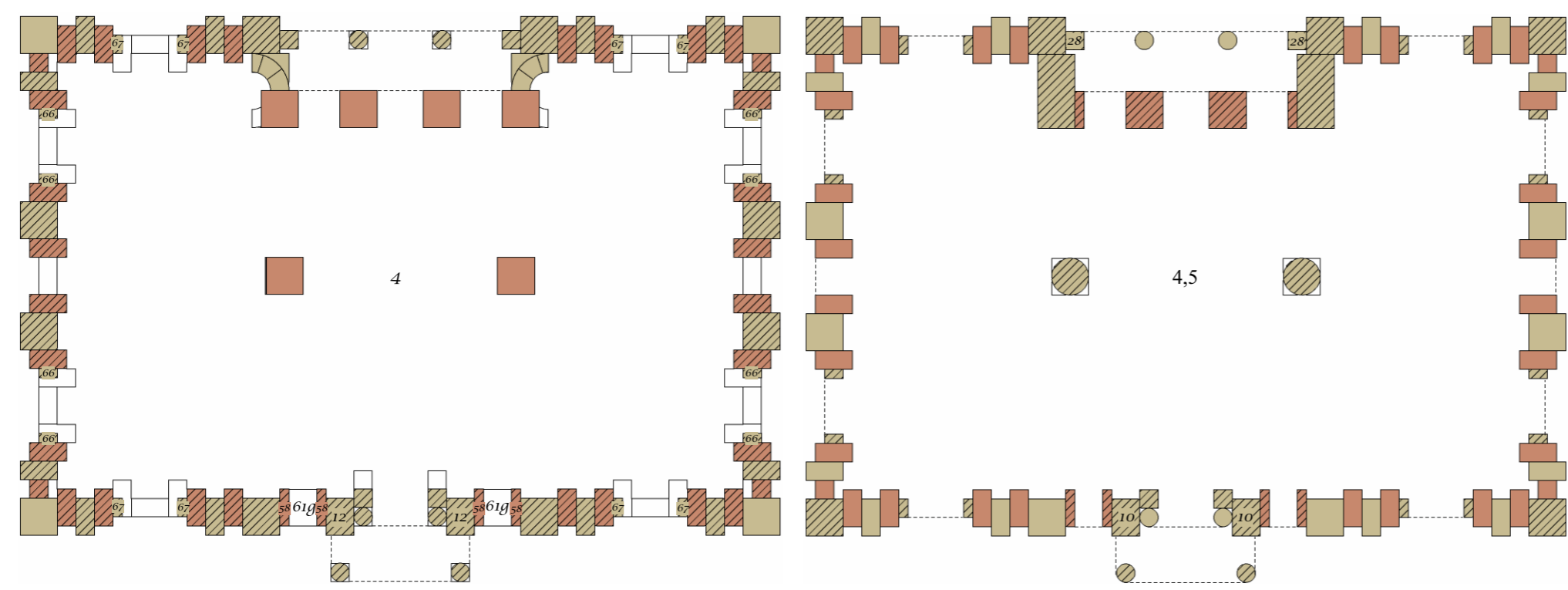
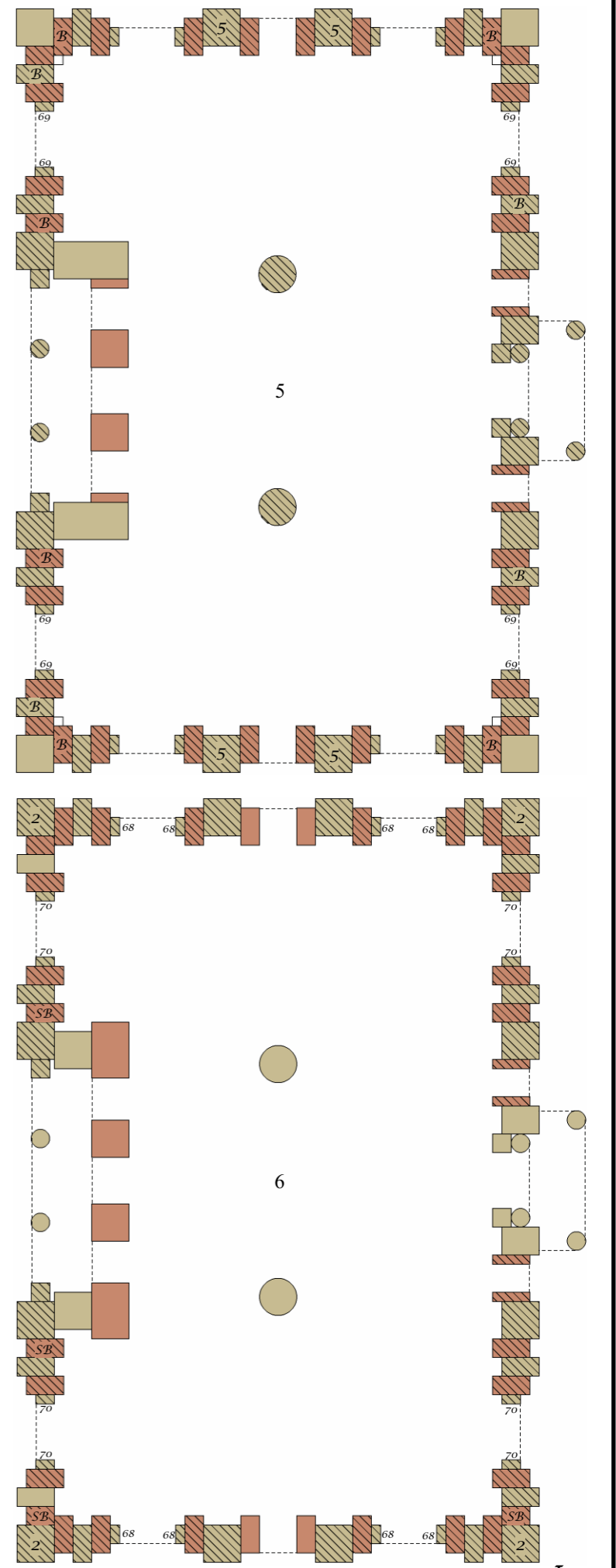
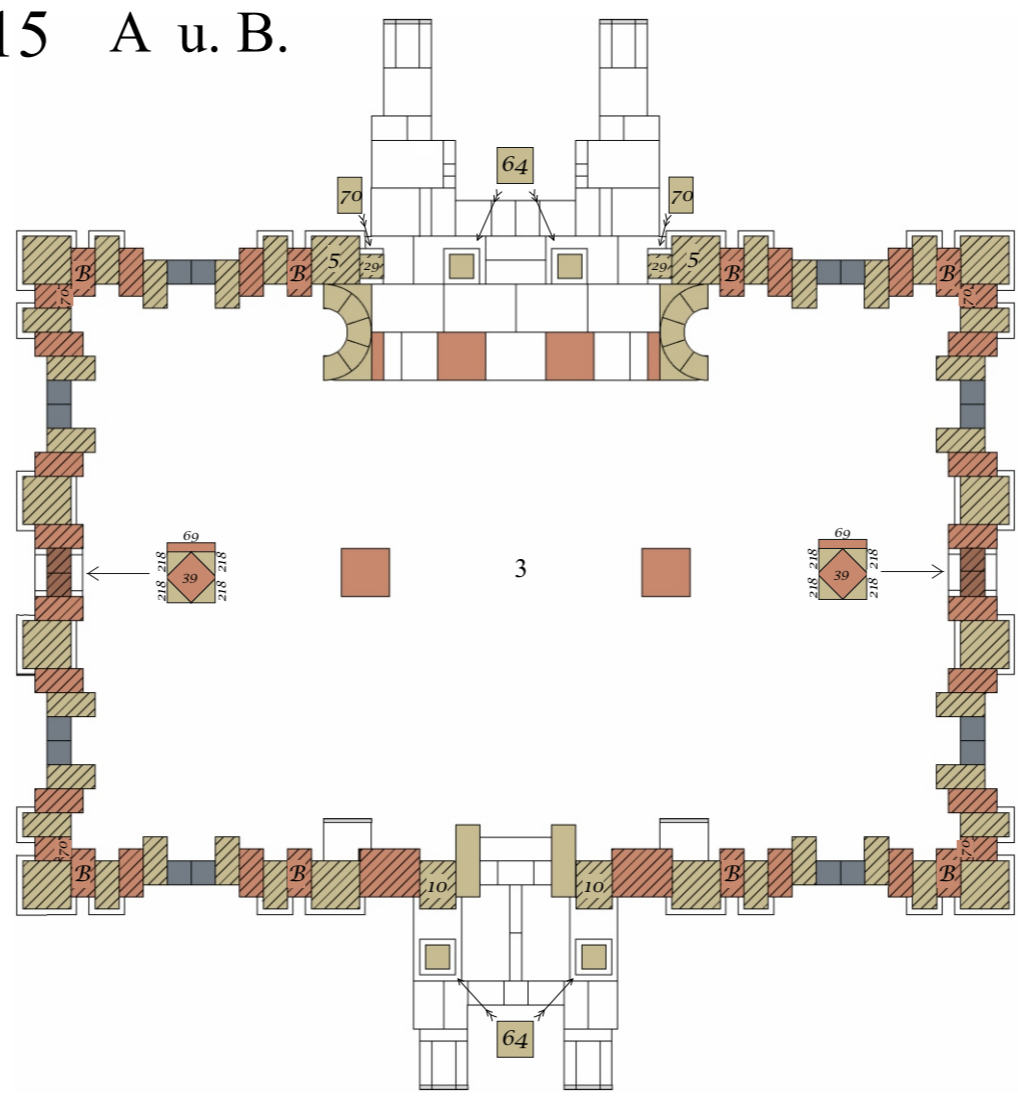
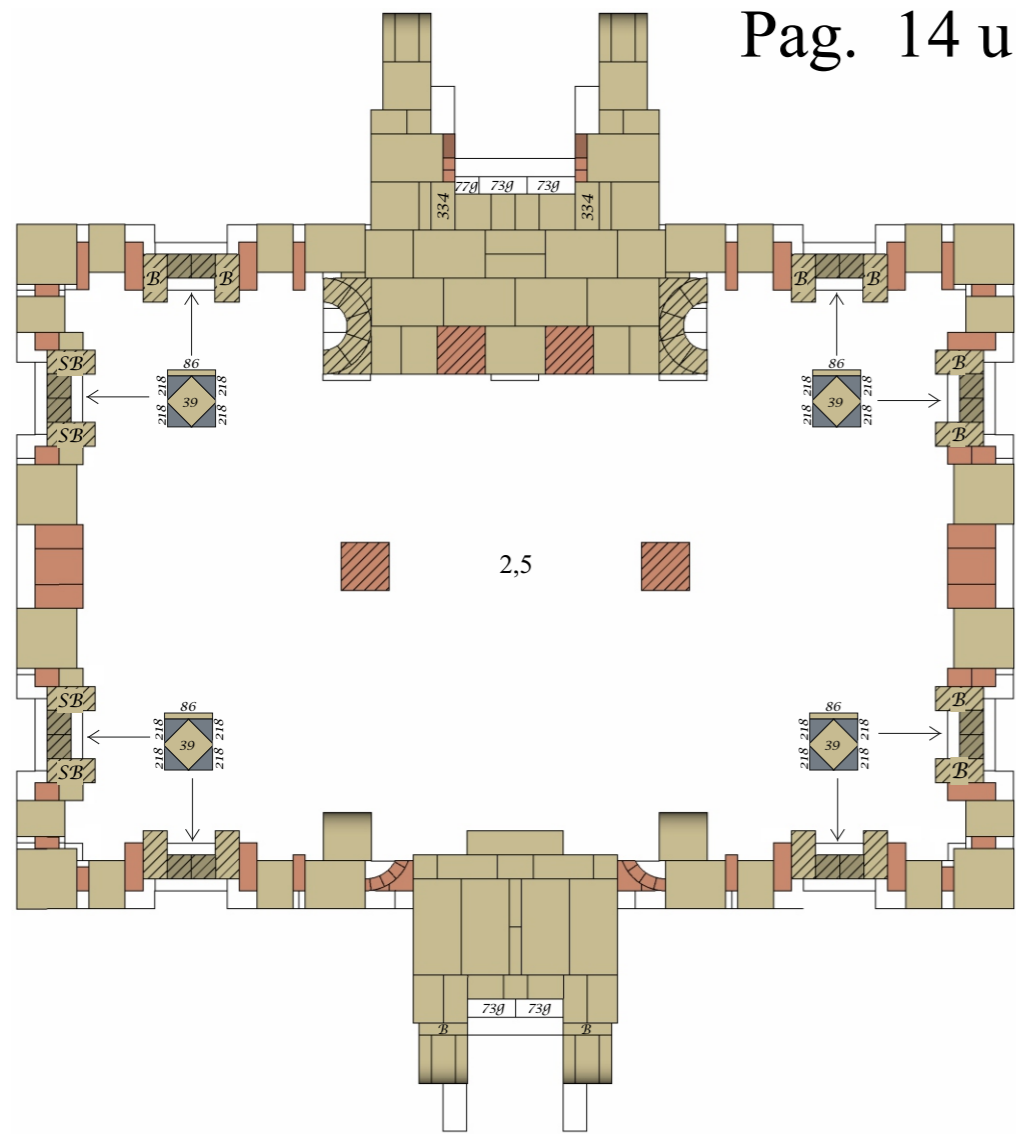

N^o 30.

B. I. K.

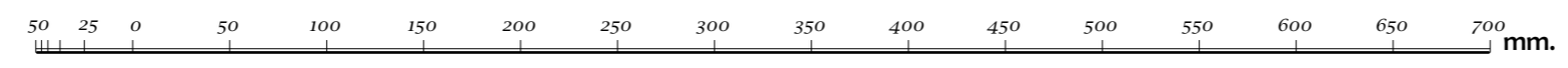

I-17

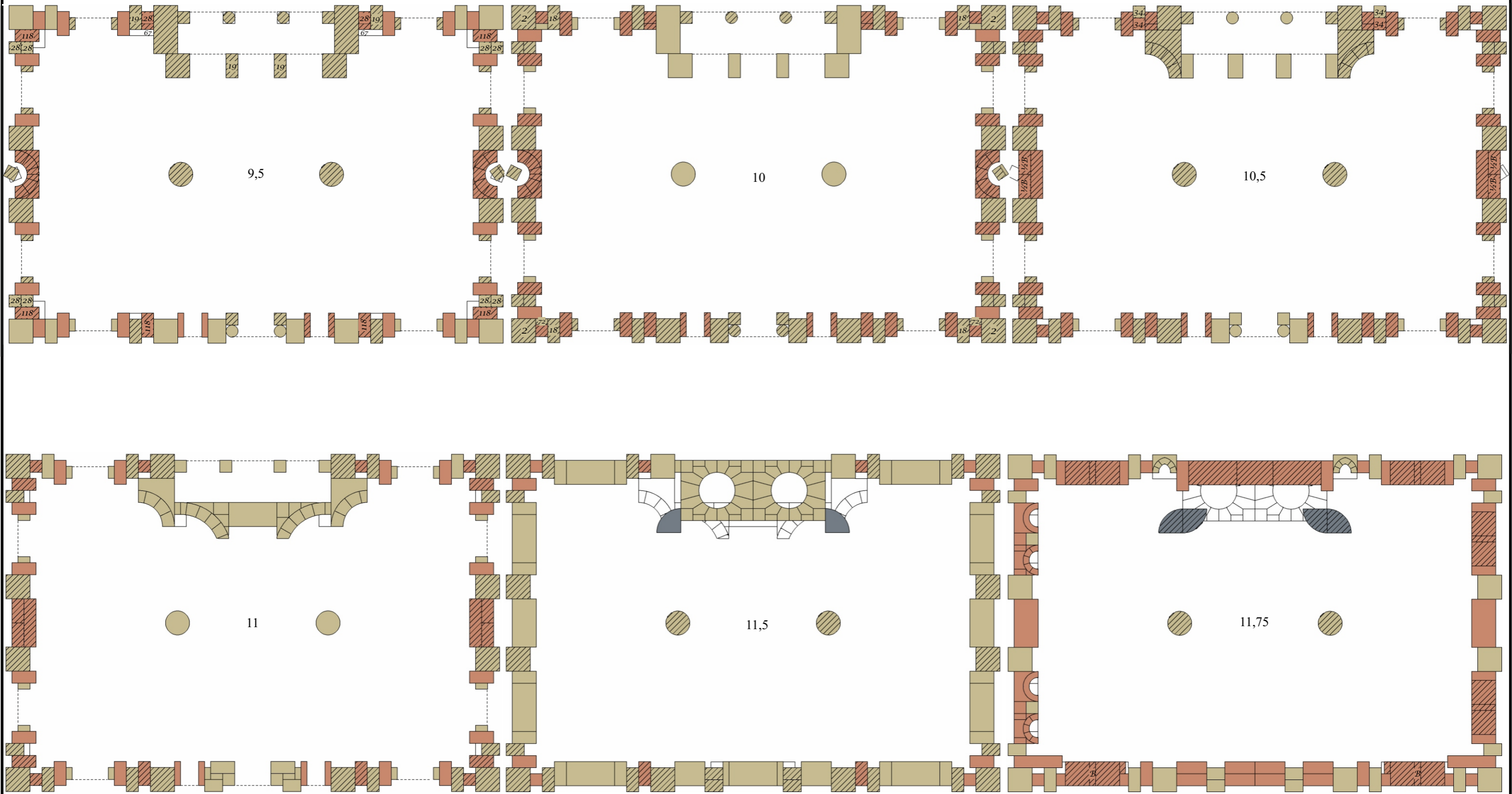

N^o 30.

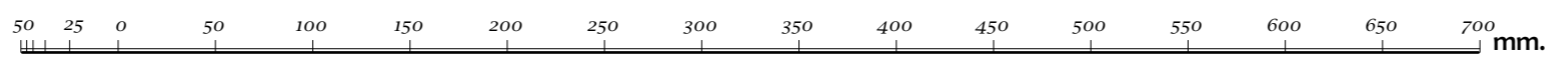

B. I. K.

I-19

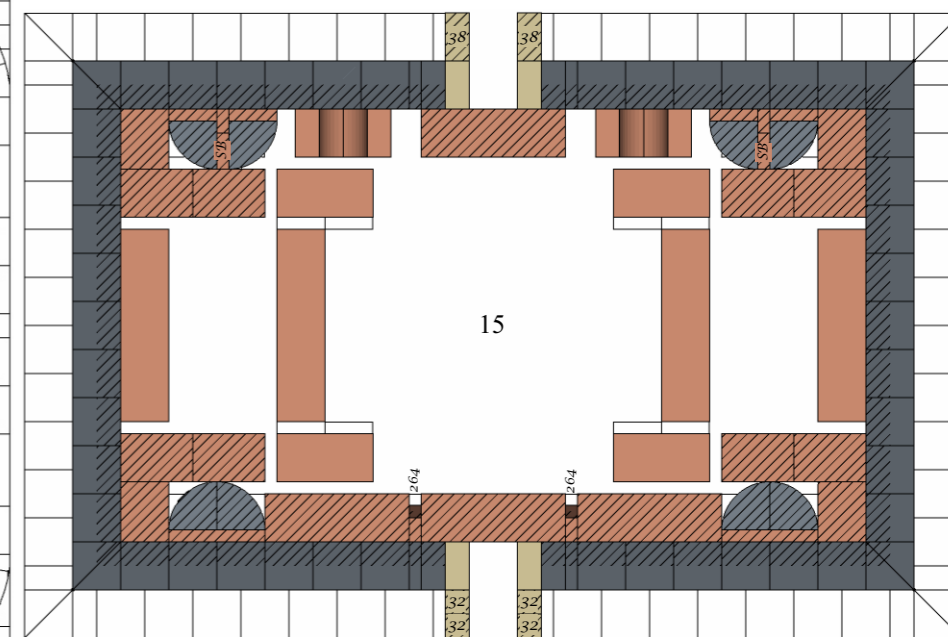
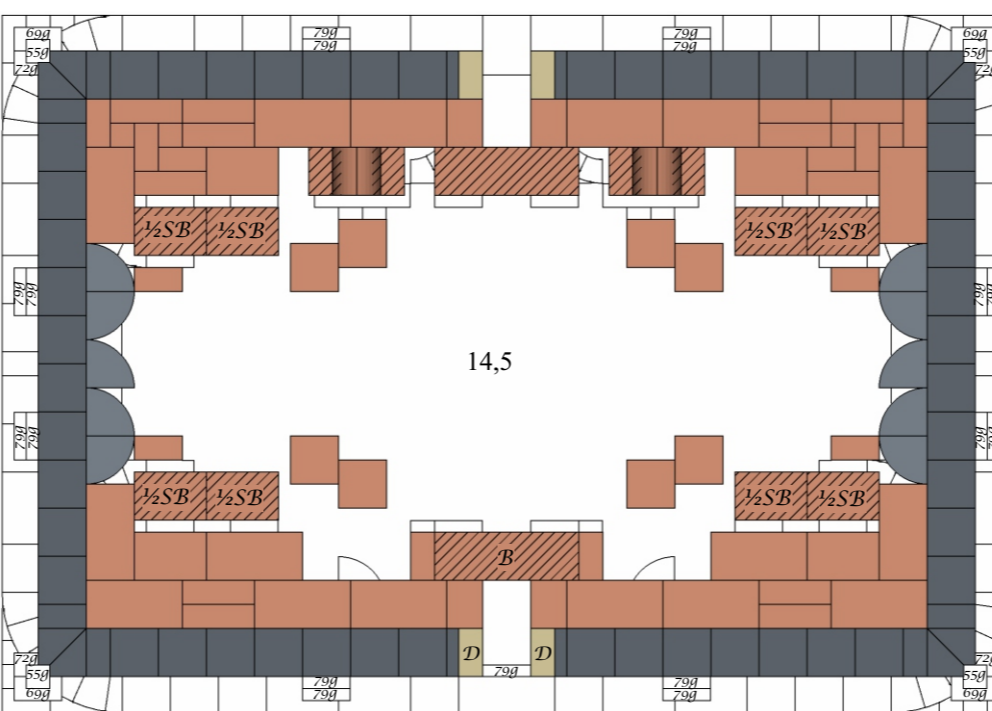
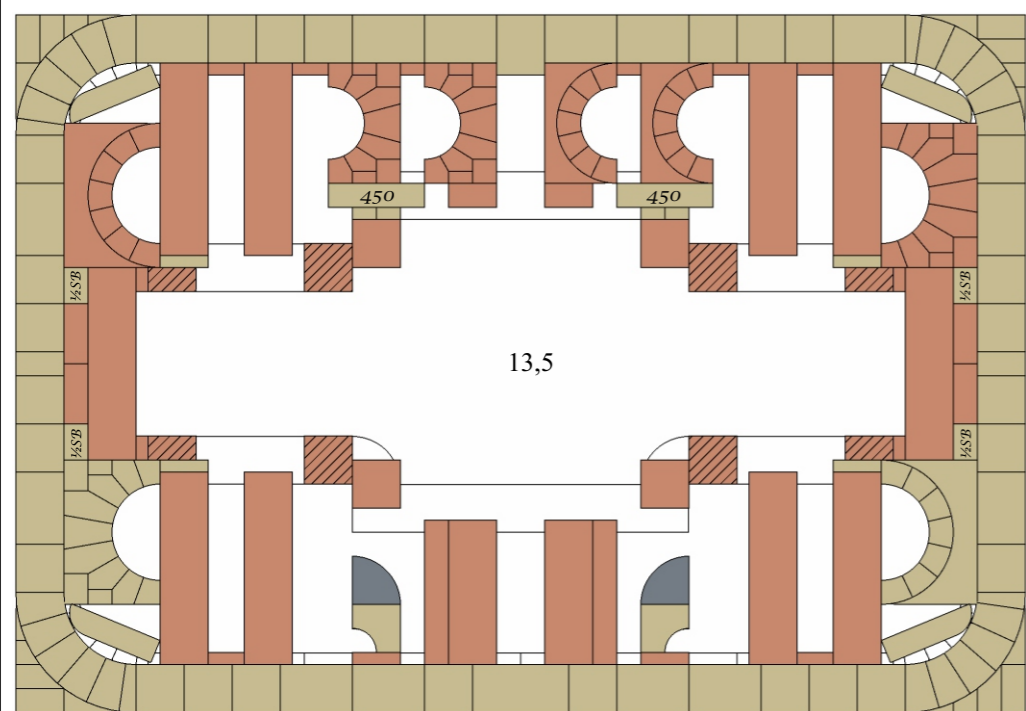
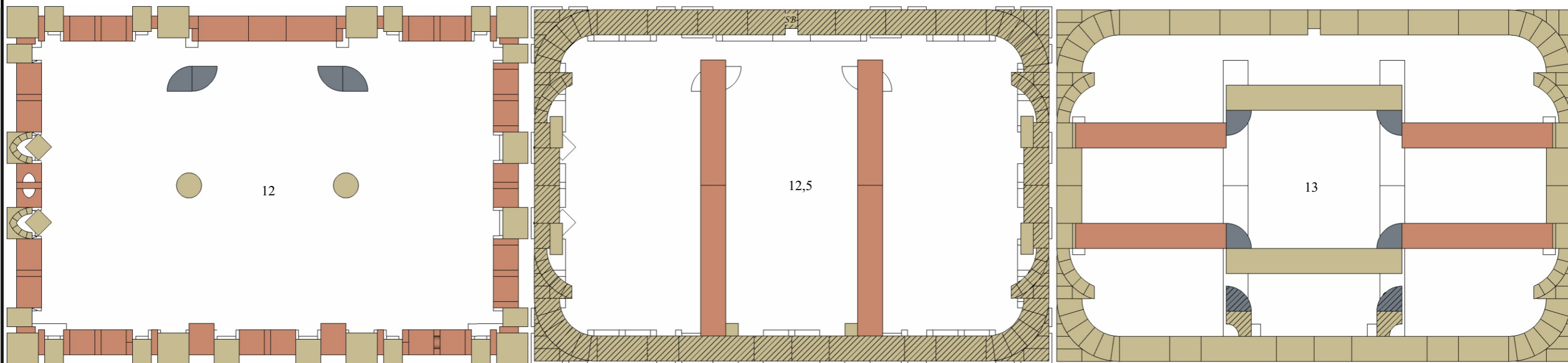

Pag. 14 u. 15 A u. B.

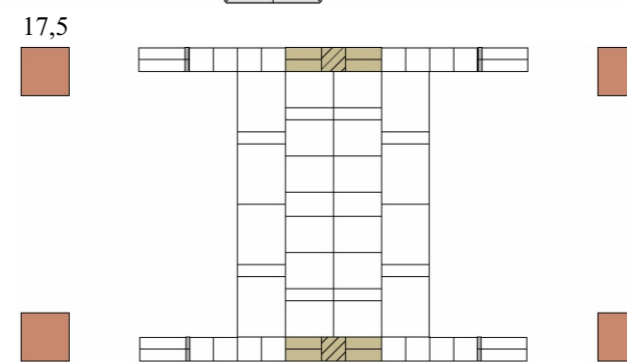
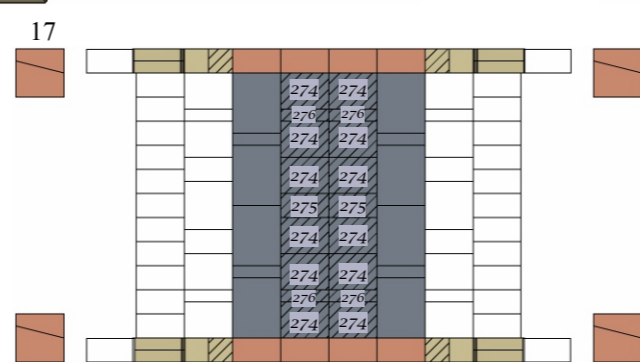
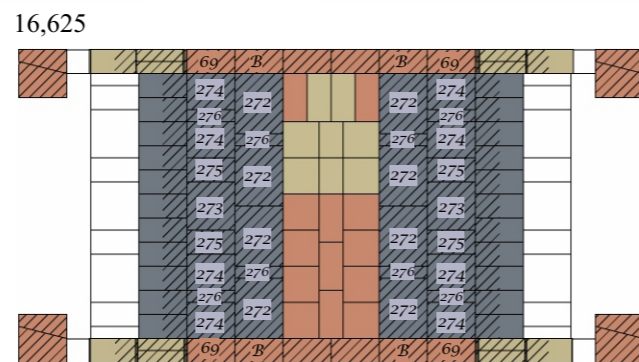
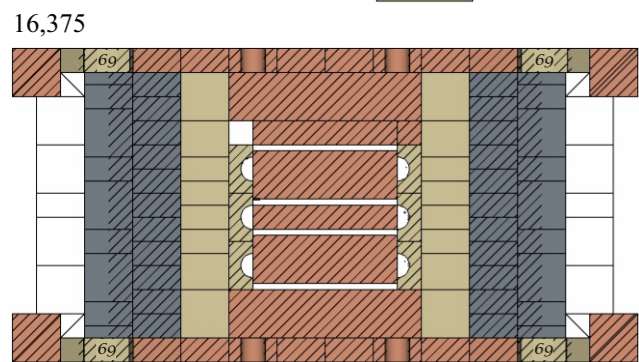
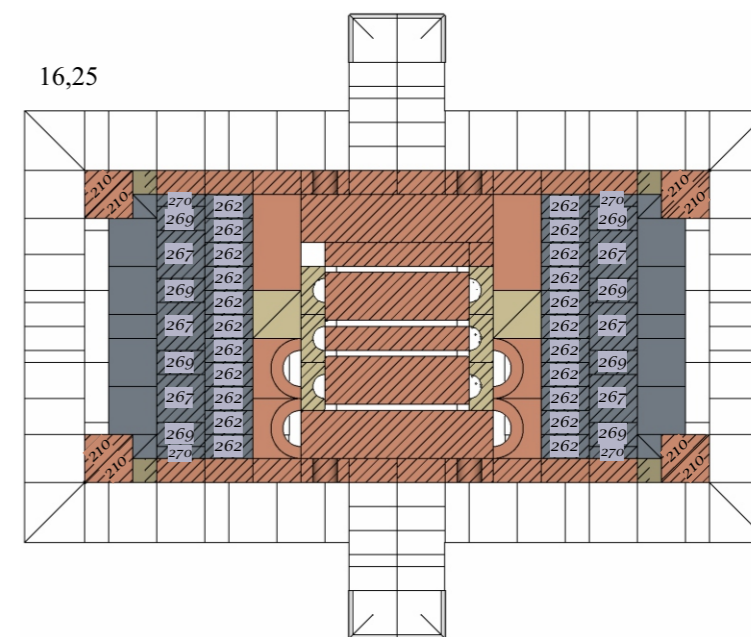
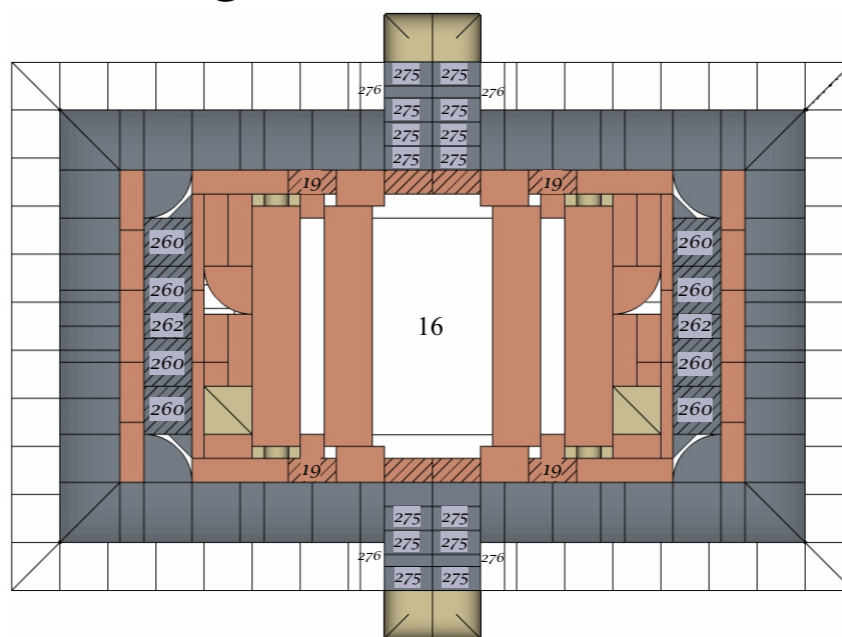
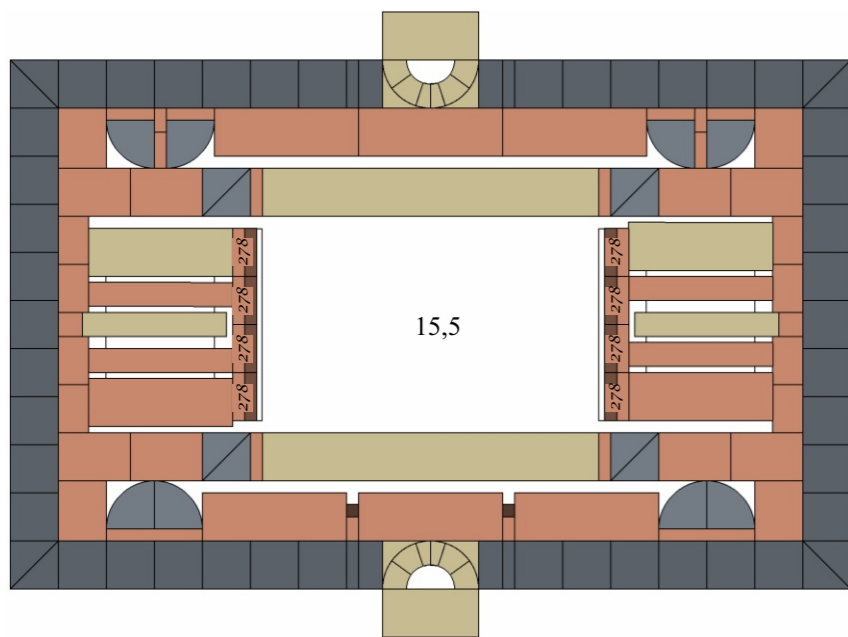

Pag. 18 u. 19 A u. B.

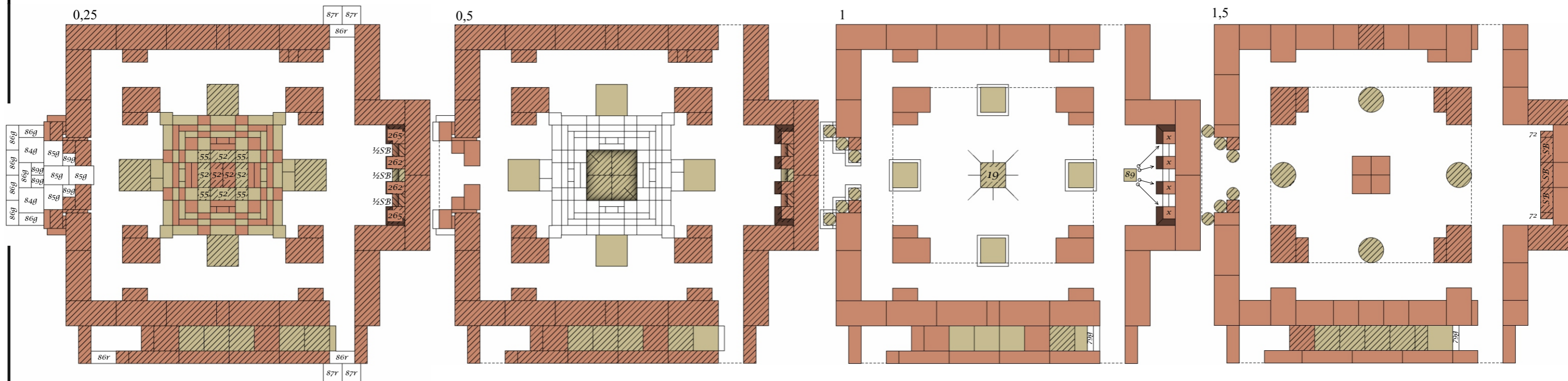

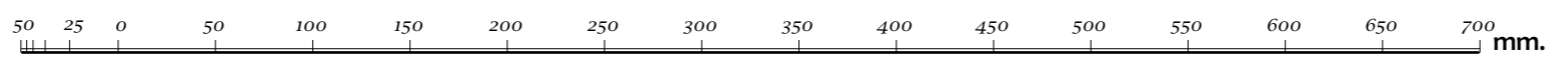
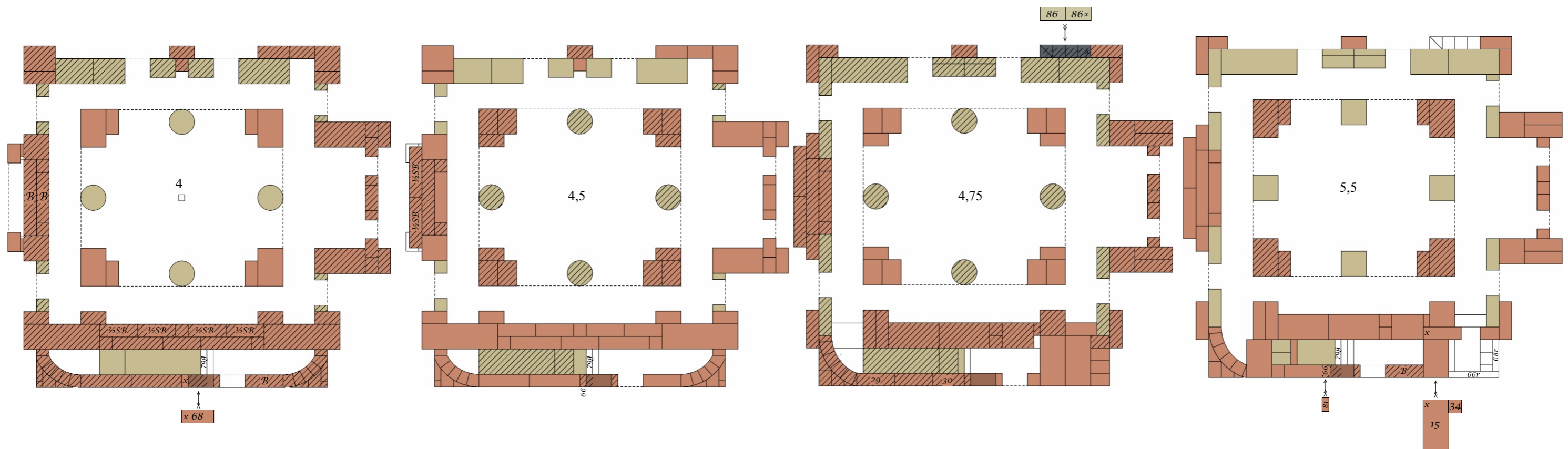
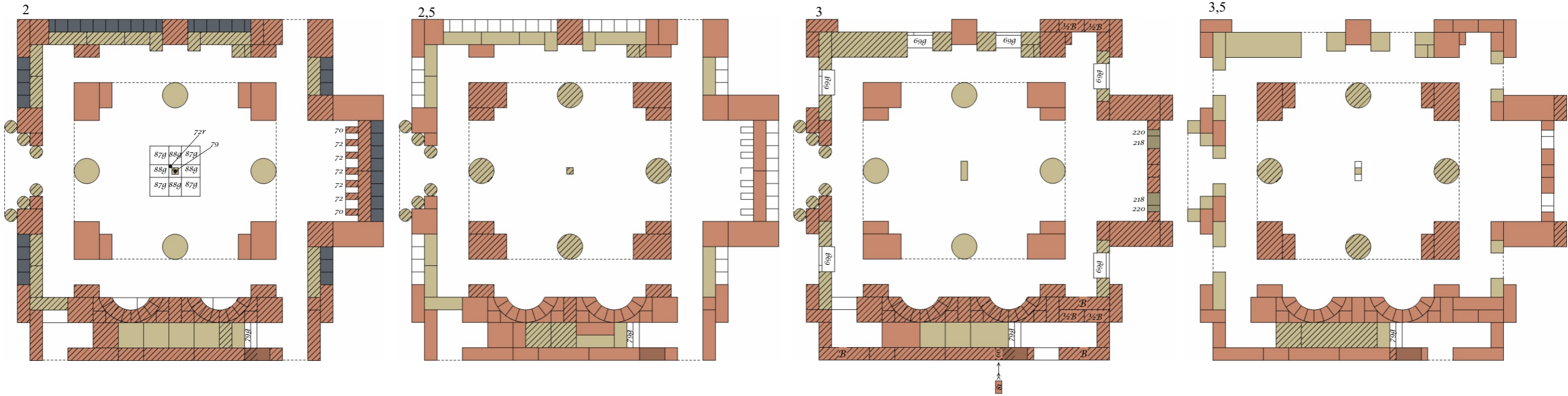

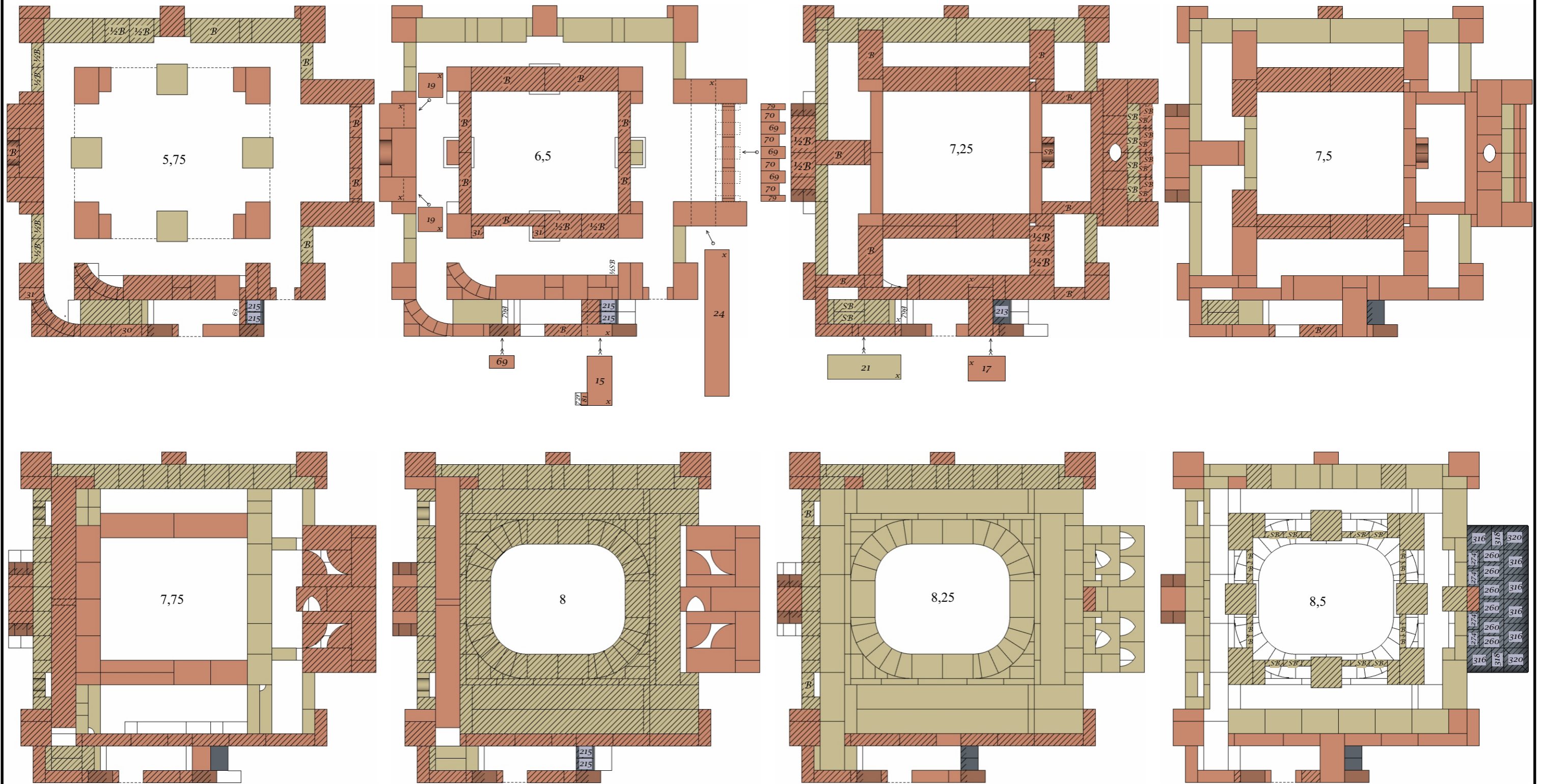

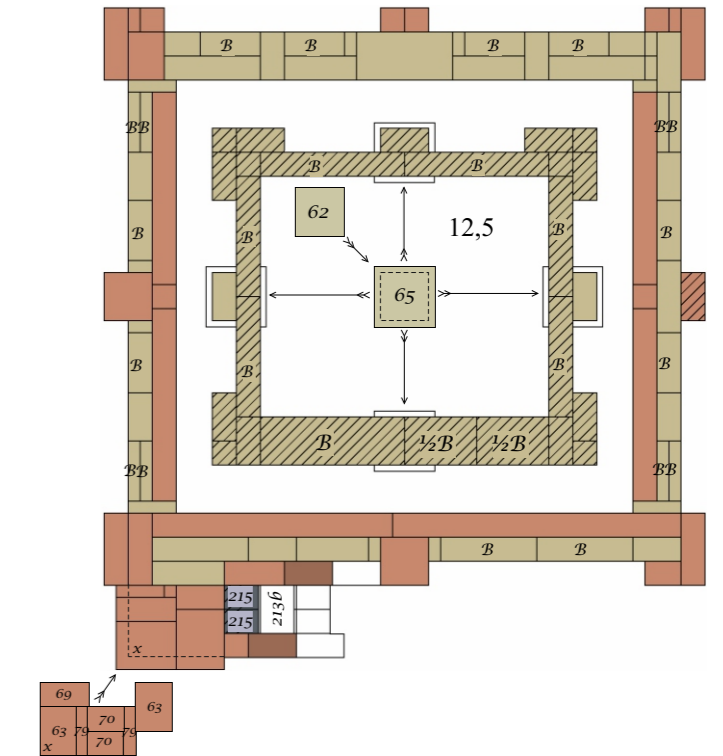
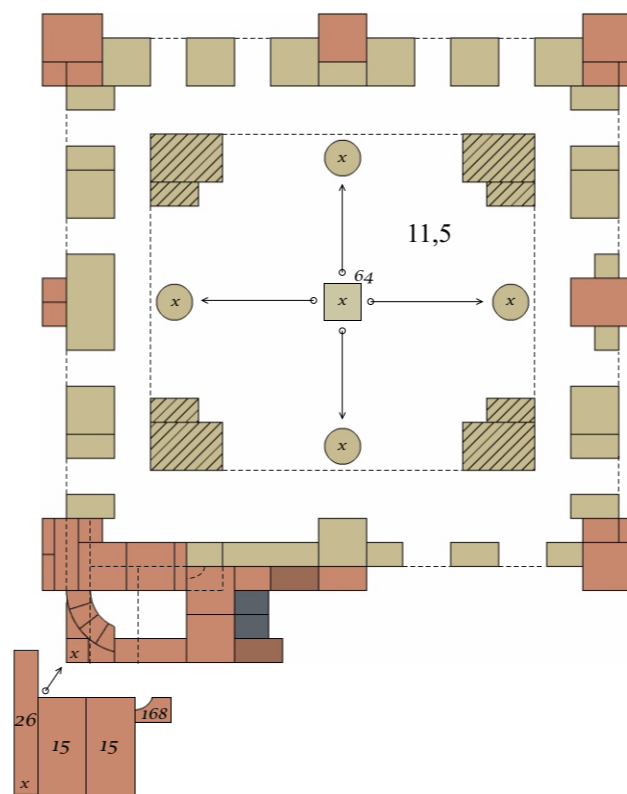
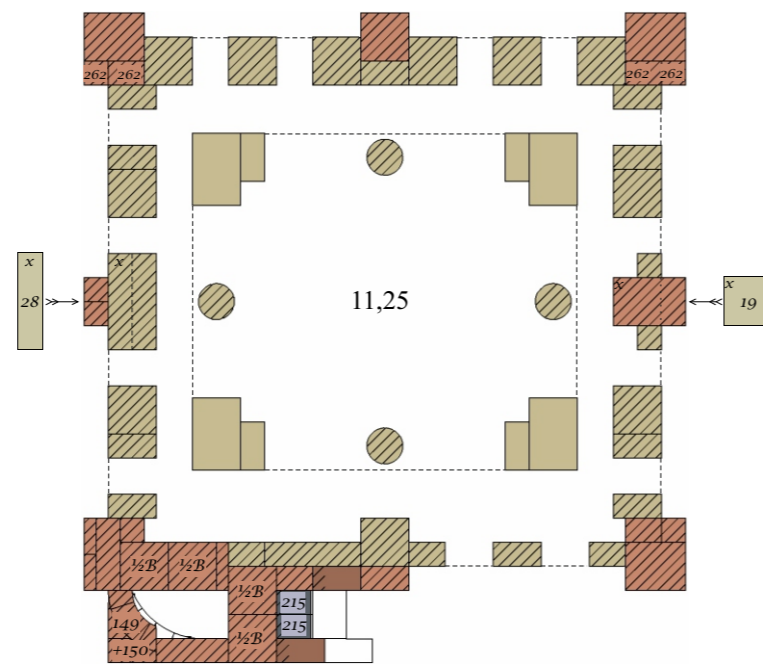
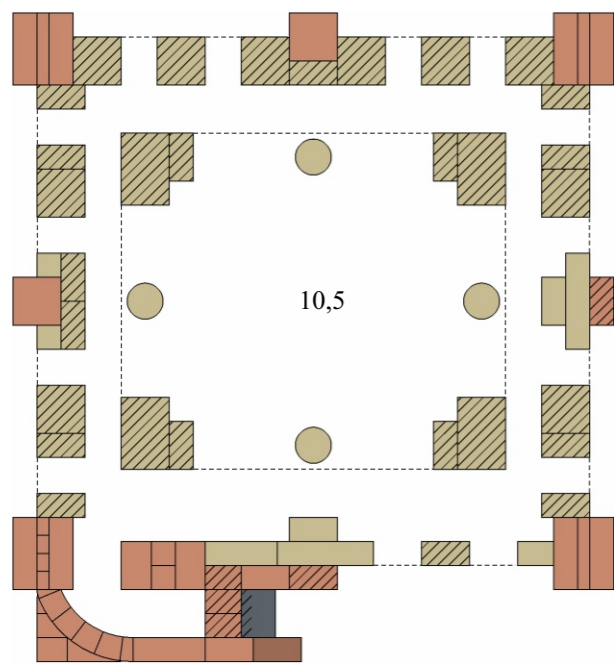
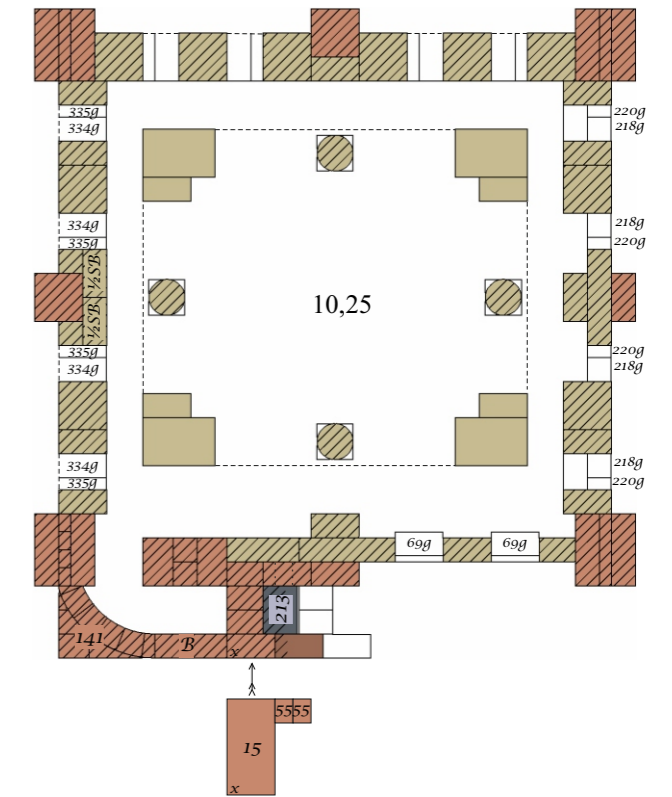
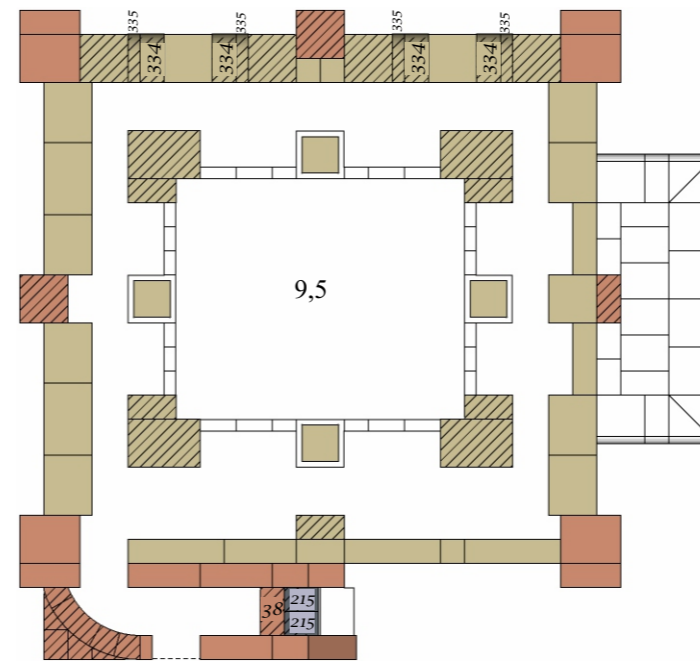
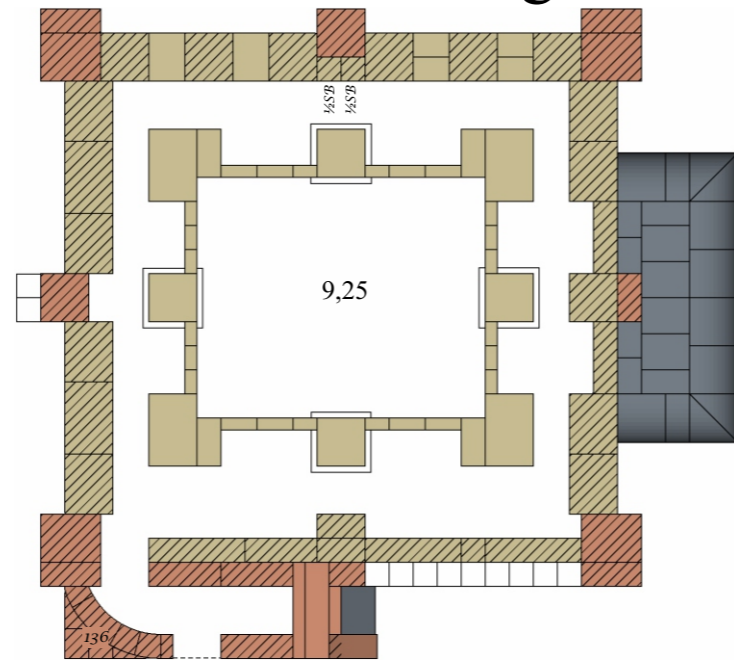
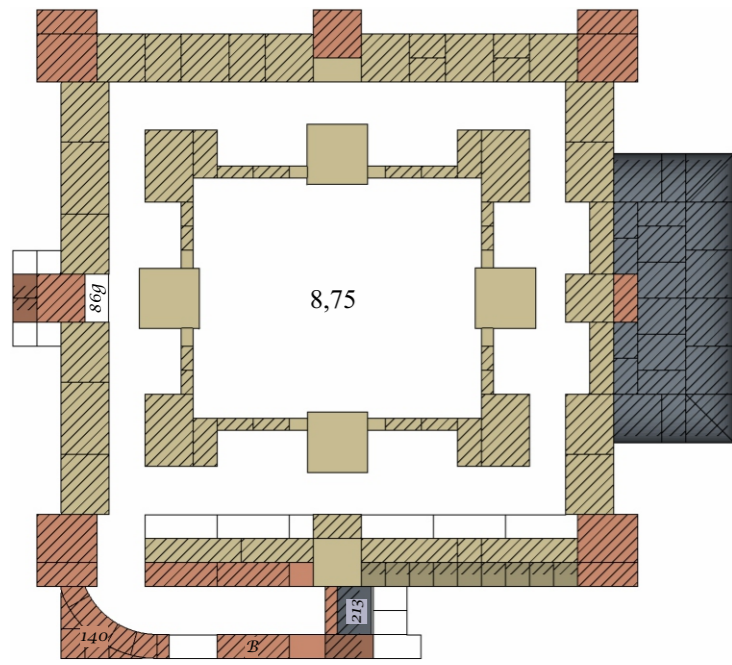

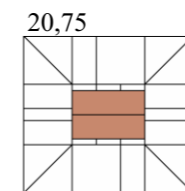
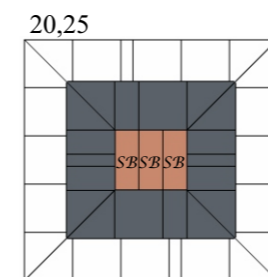
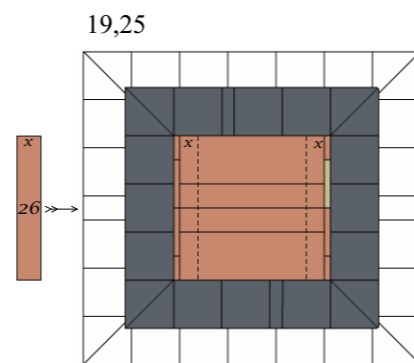
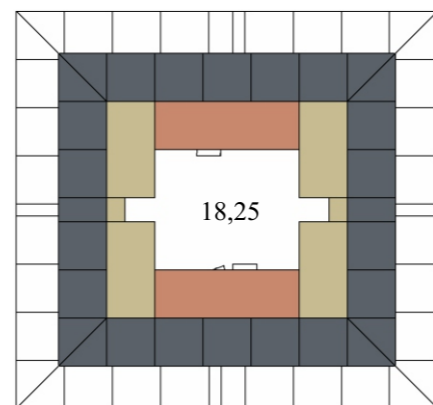
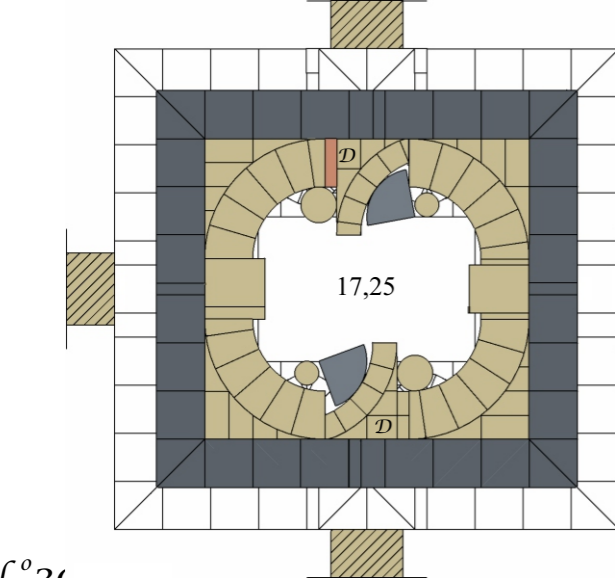
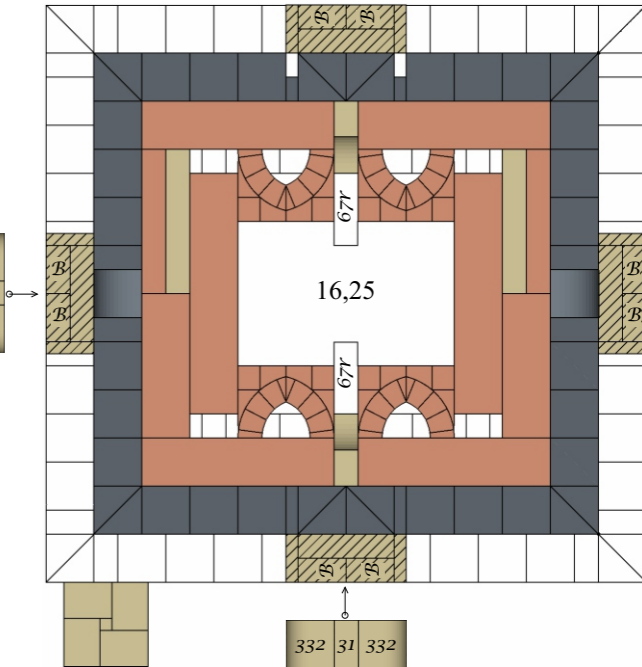
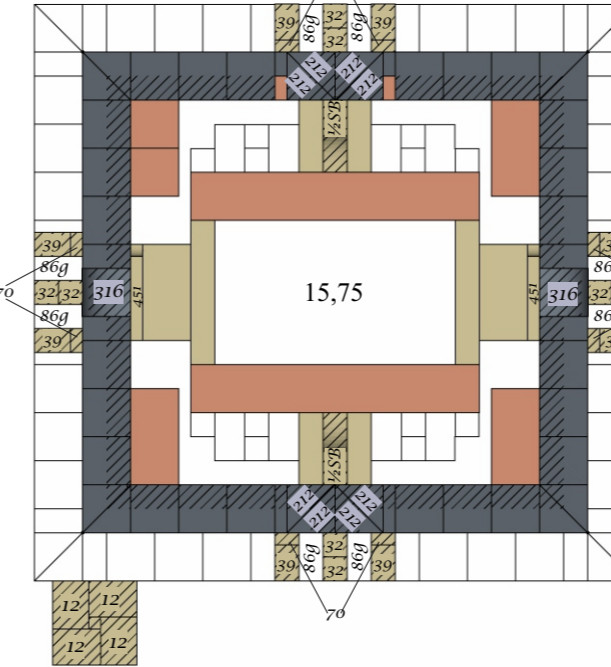
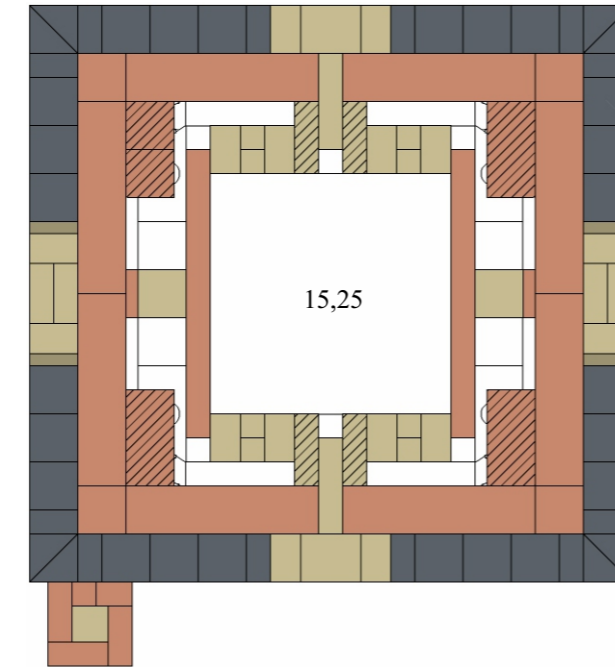
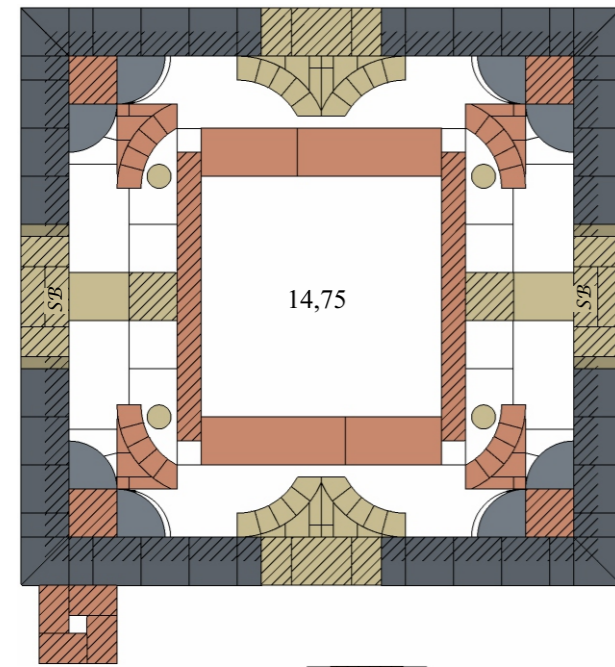
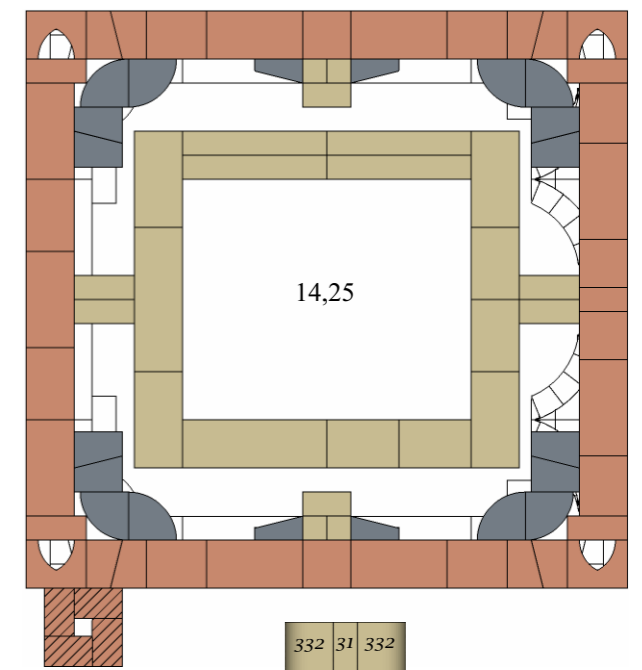
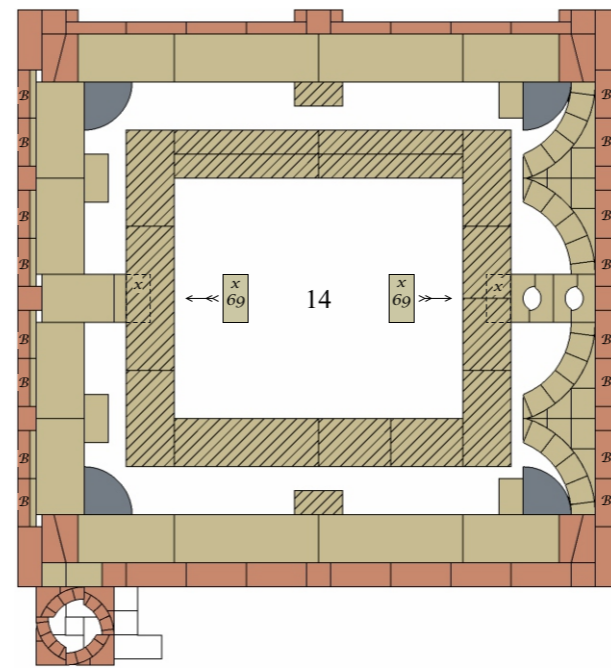
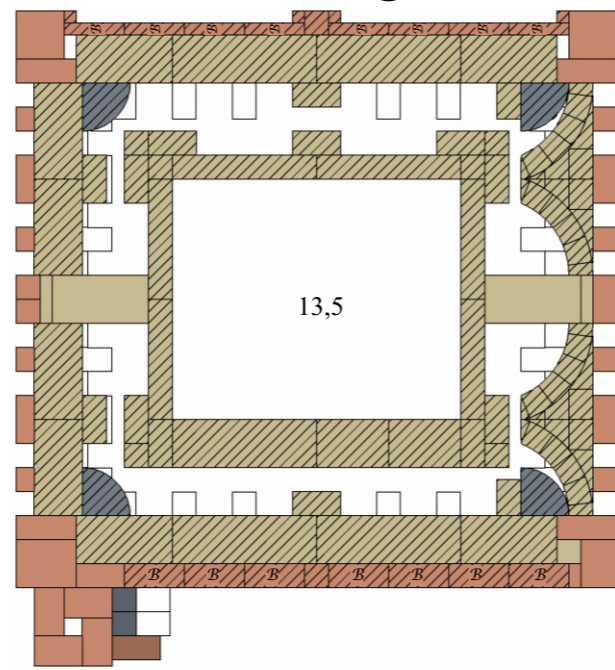
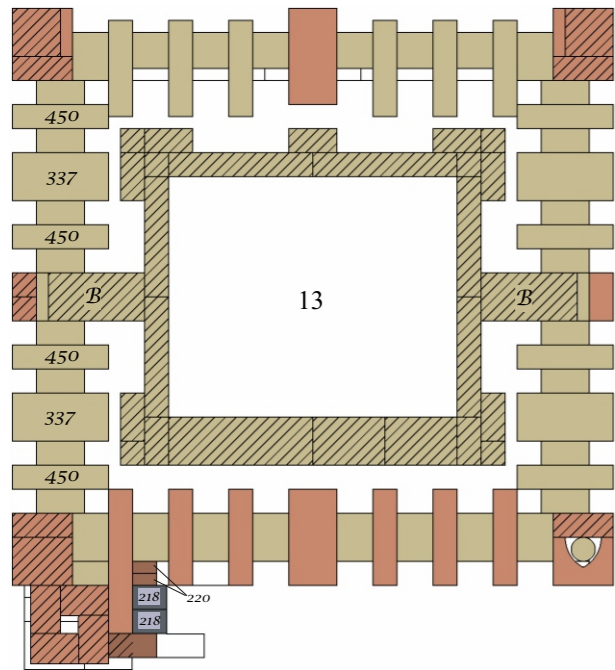

Turm

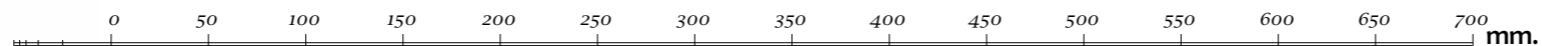
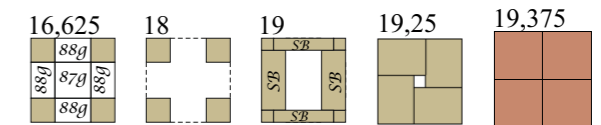



N^o 30.

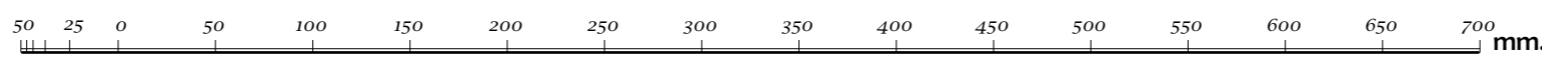

B. I. K.

I-27



N^o 30.

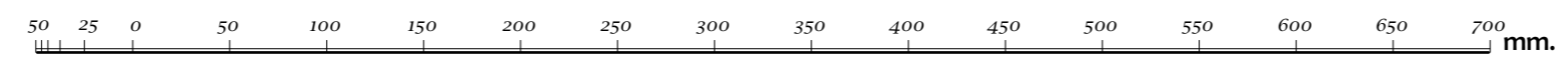

B. I. K.

↑ 17 ↑ 17
I-28

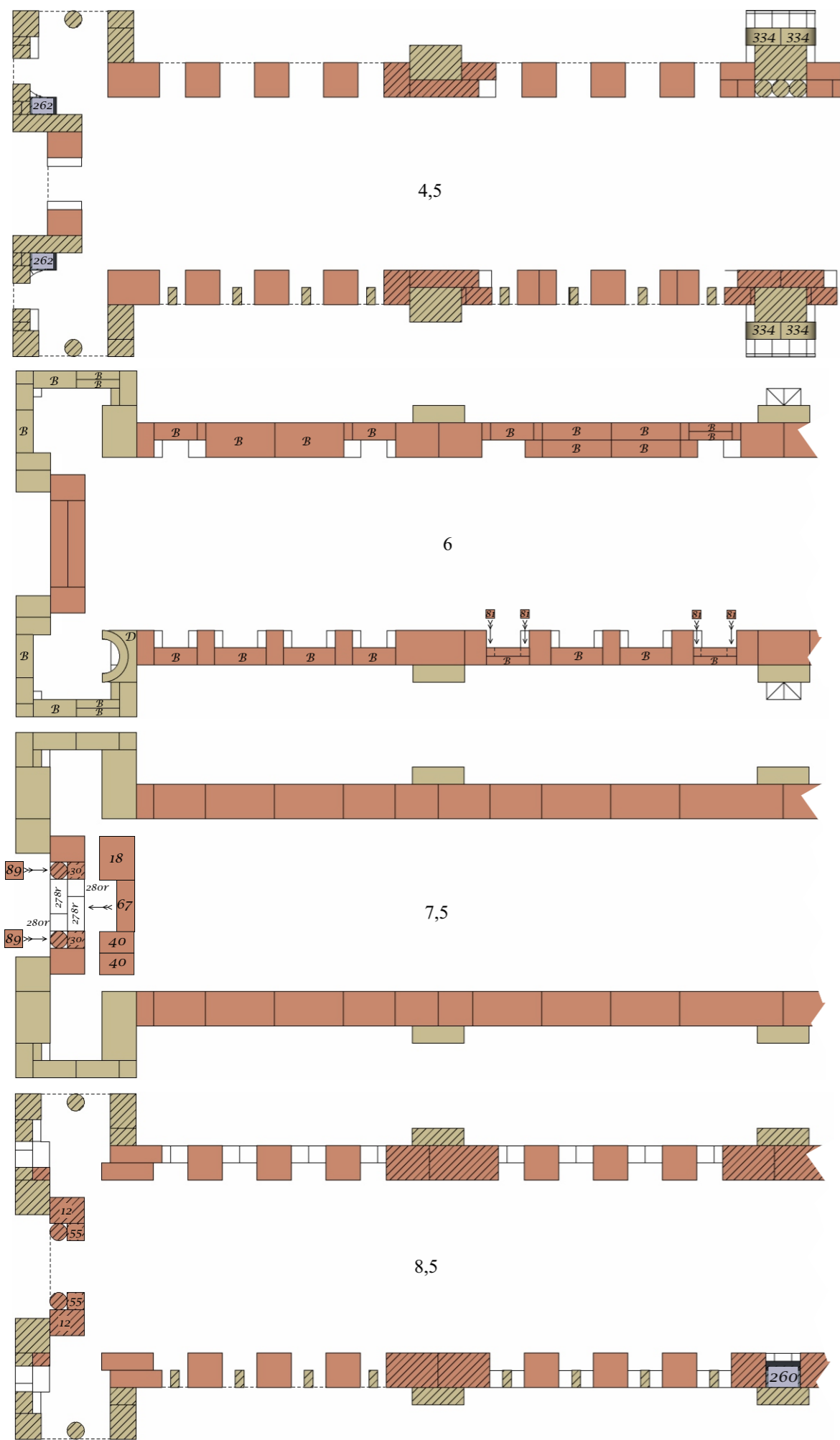

N^o 32.

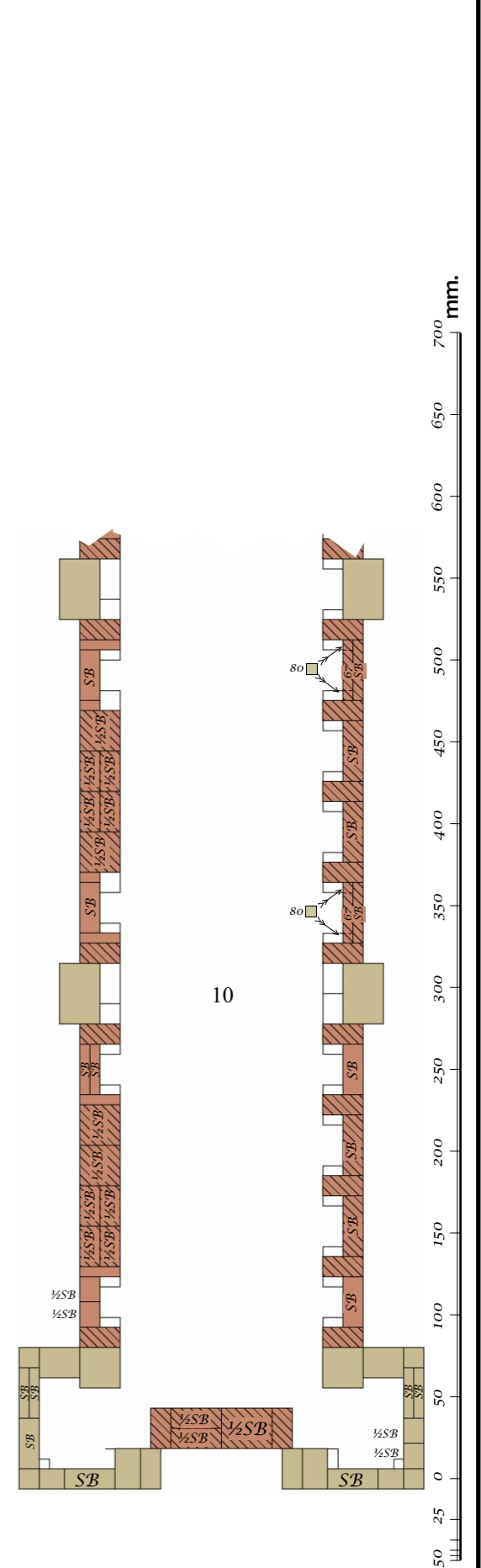
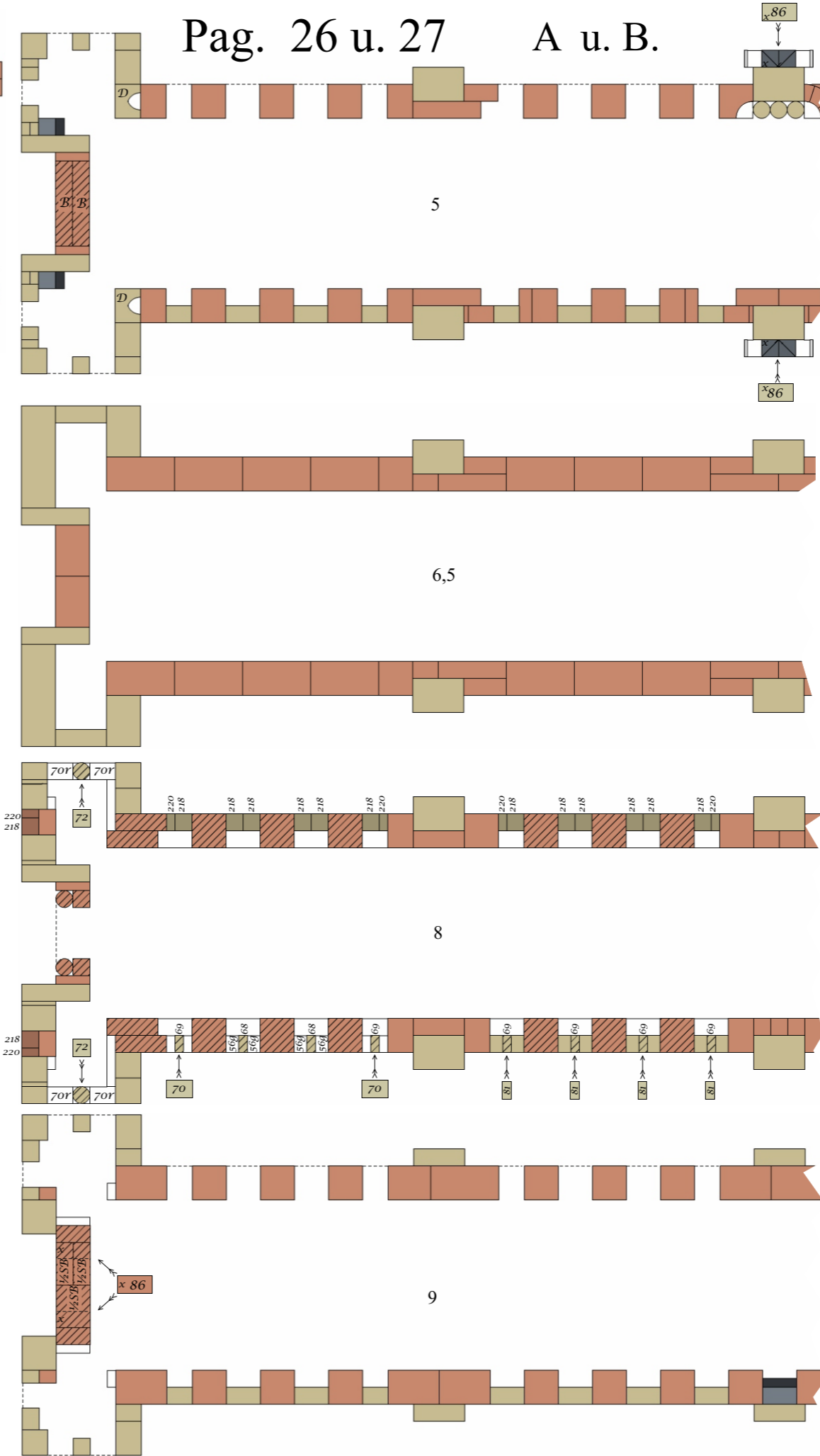

B. I. K.

I-30

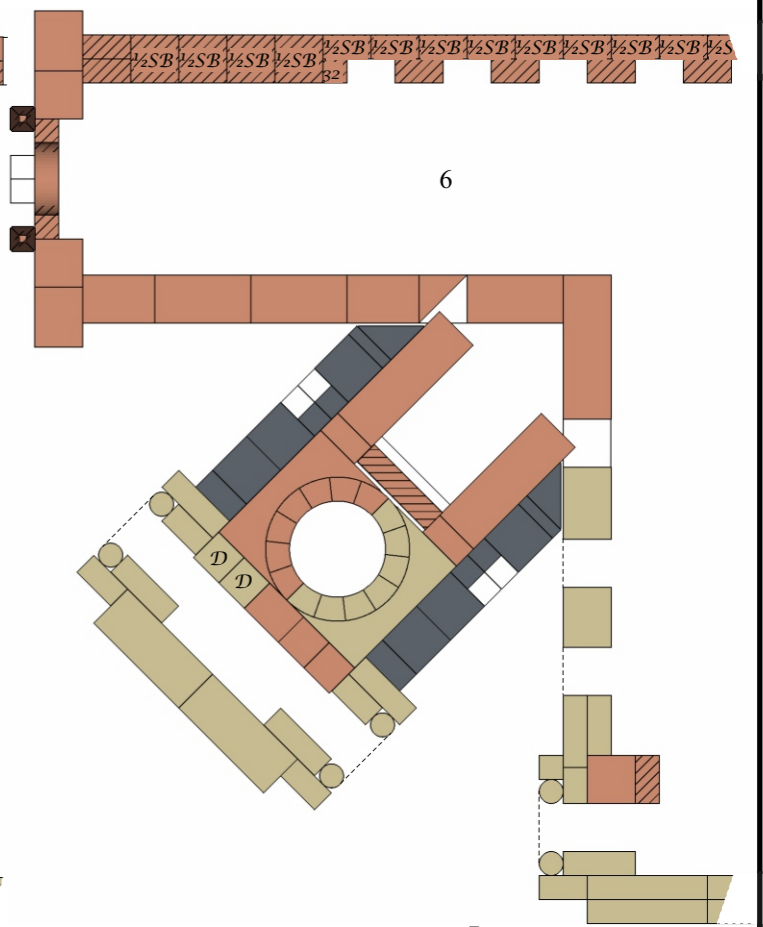
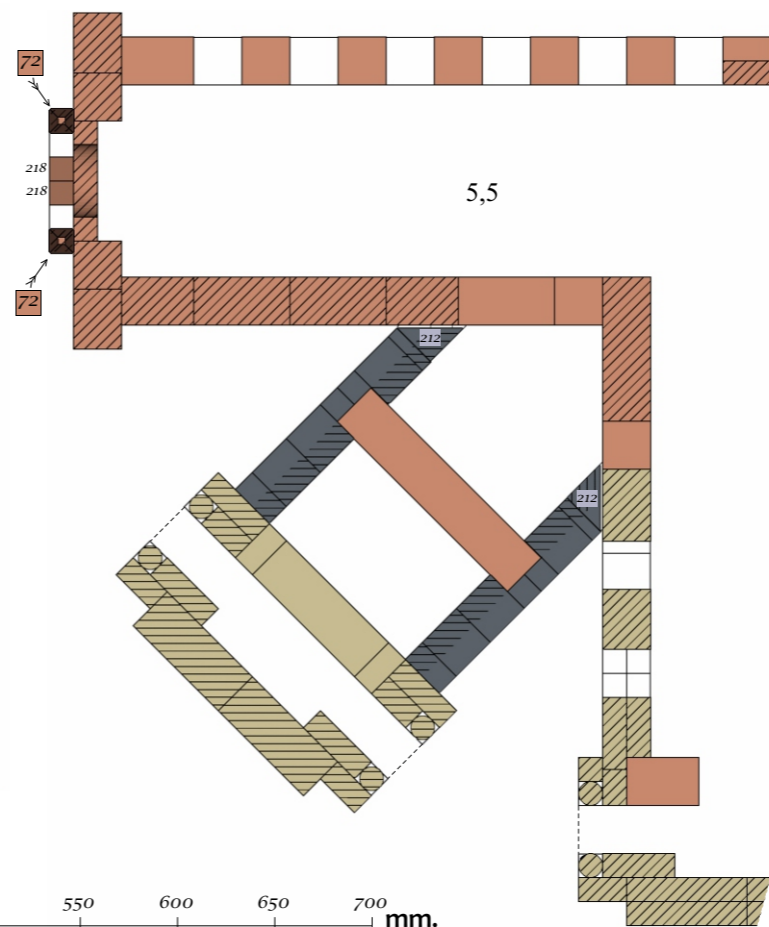
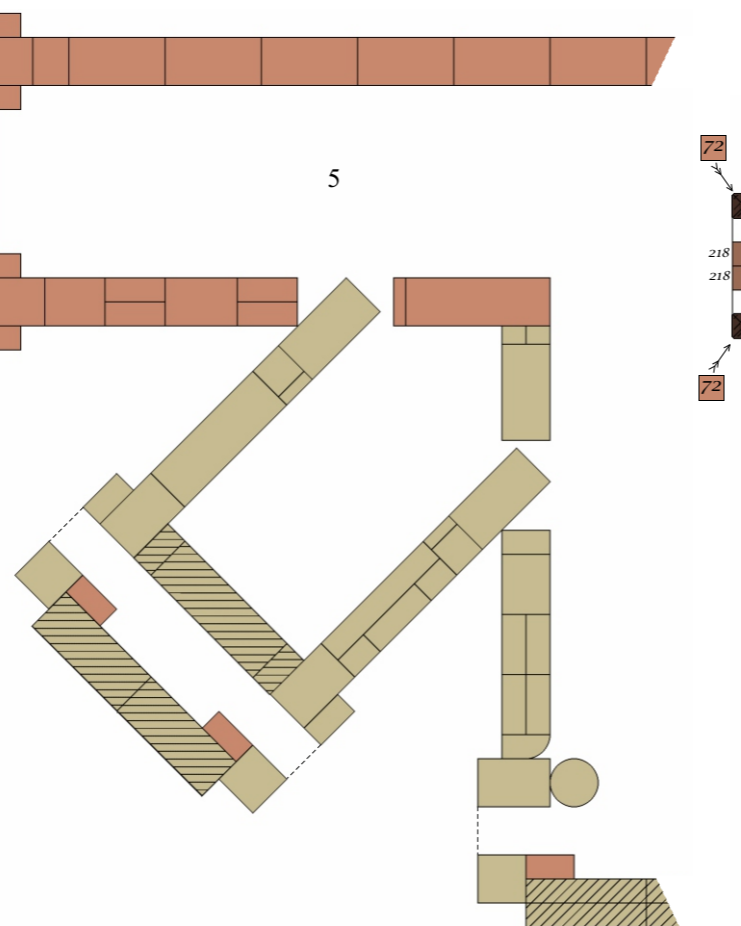
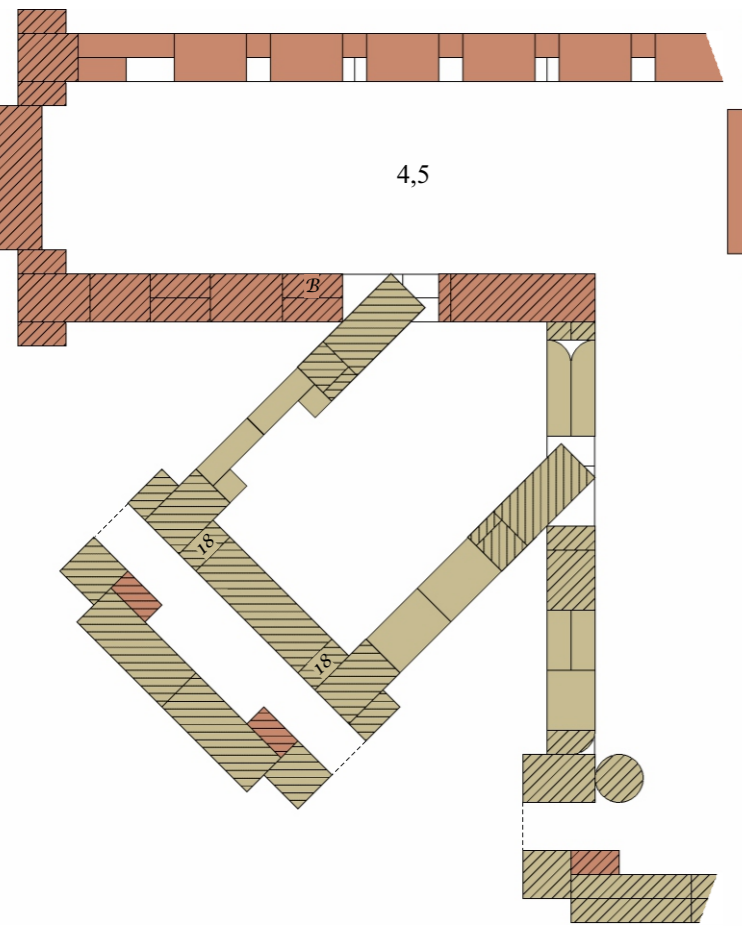
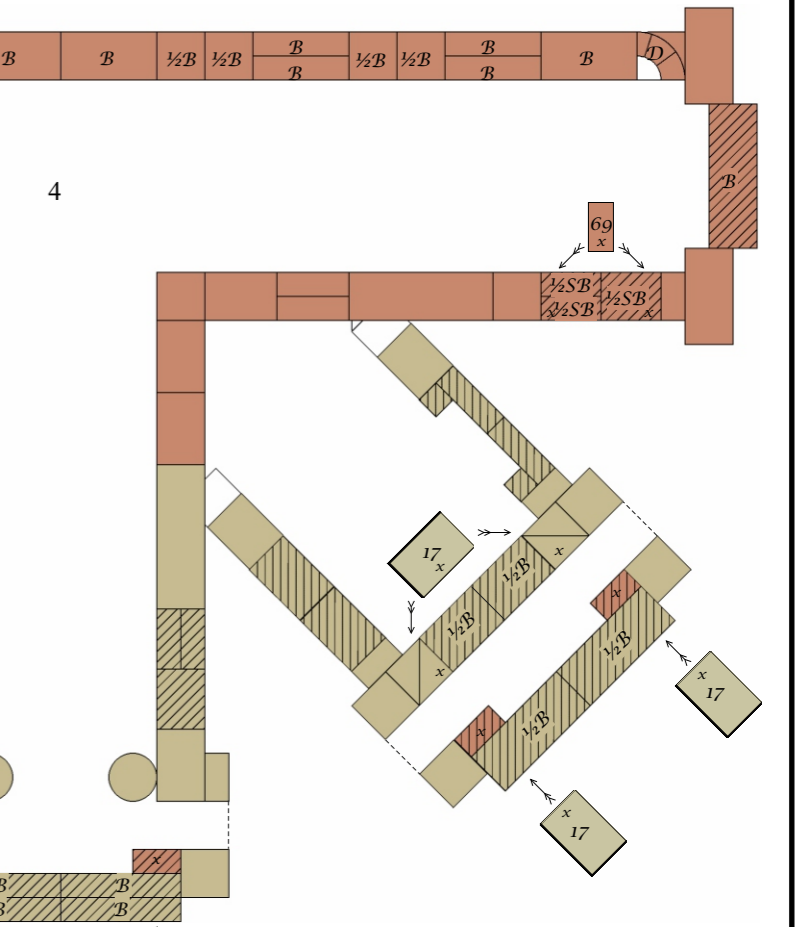
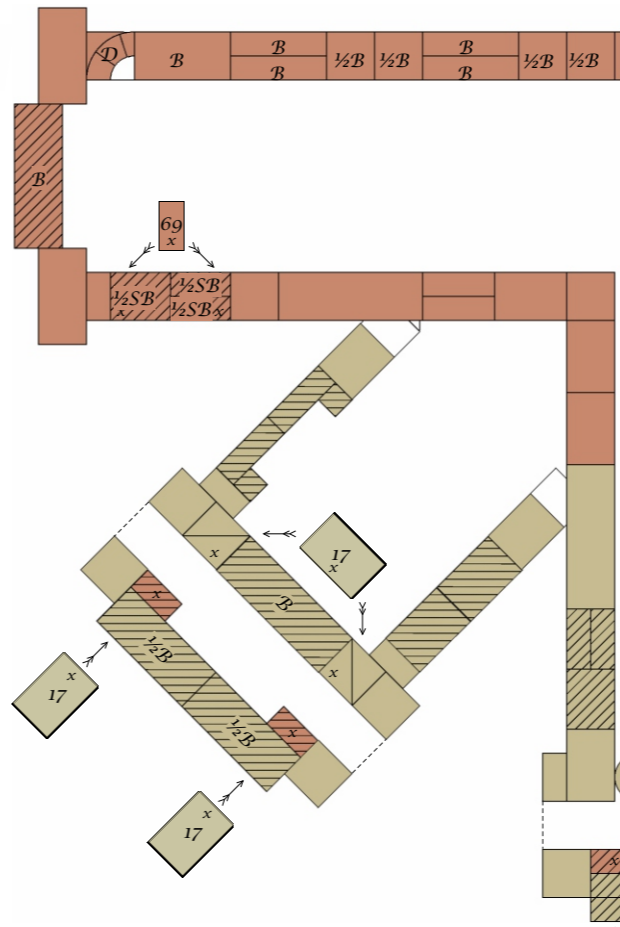
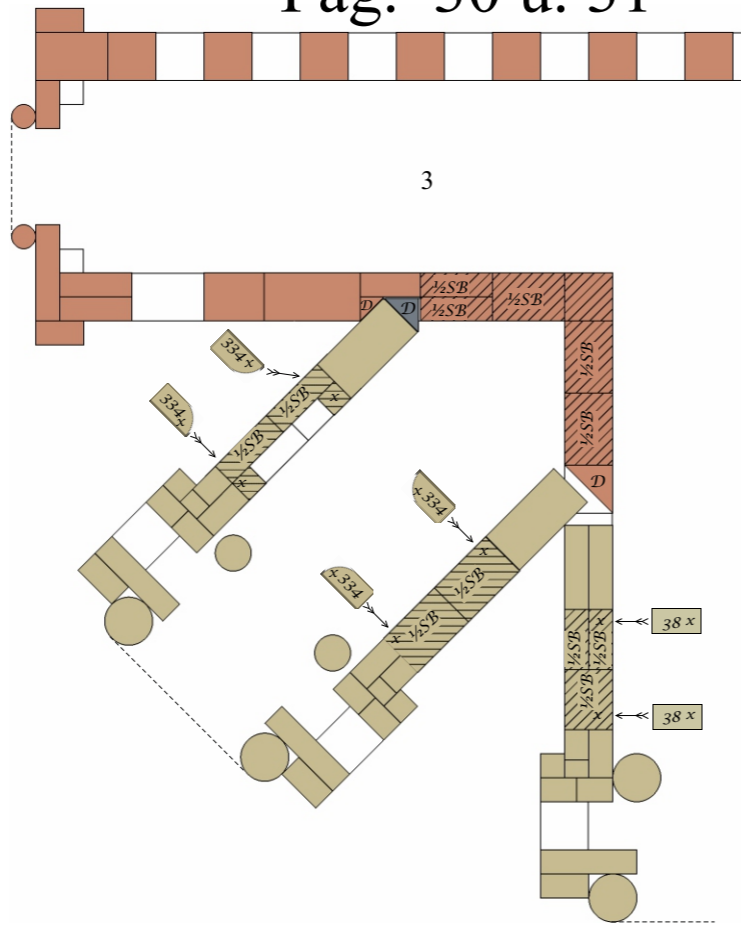
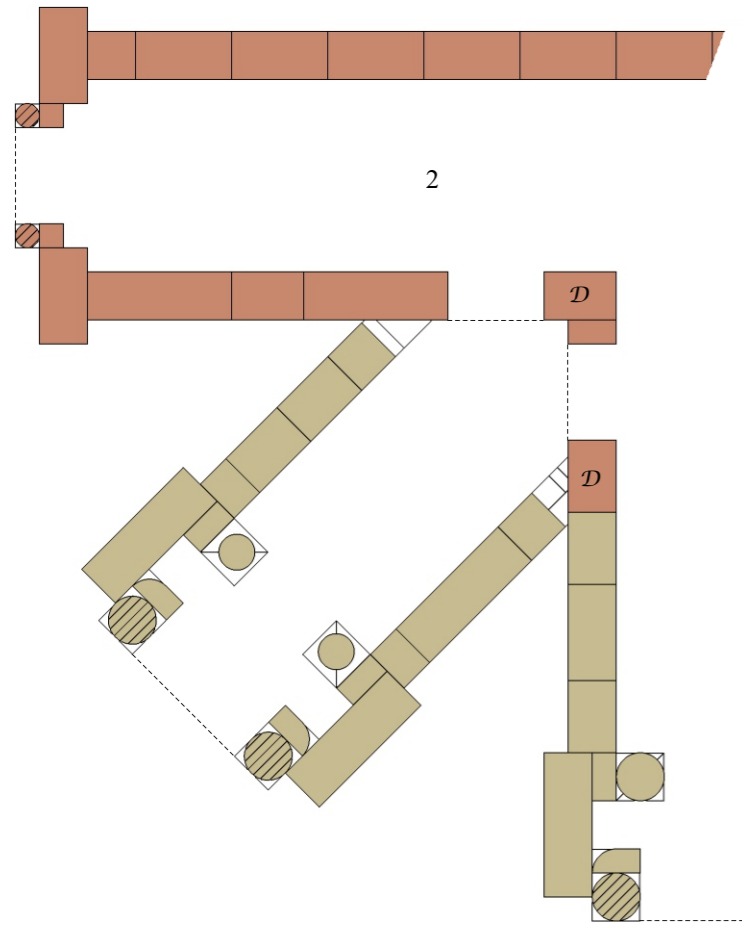

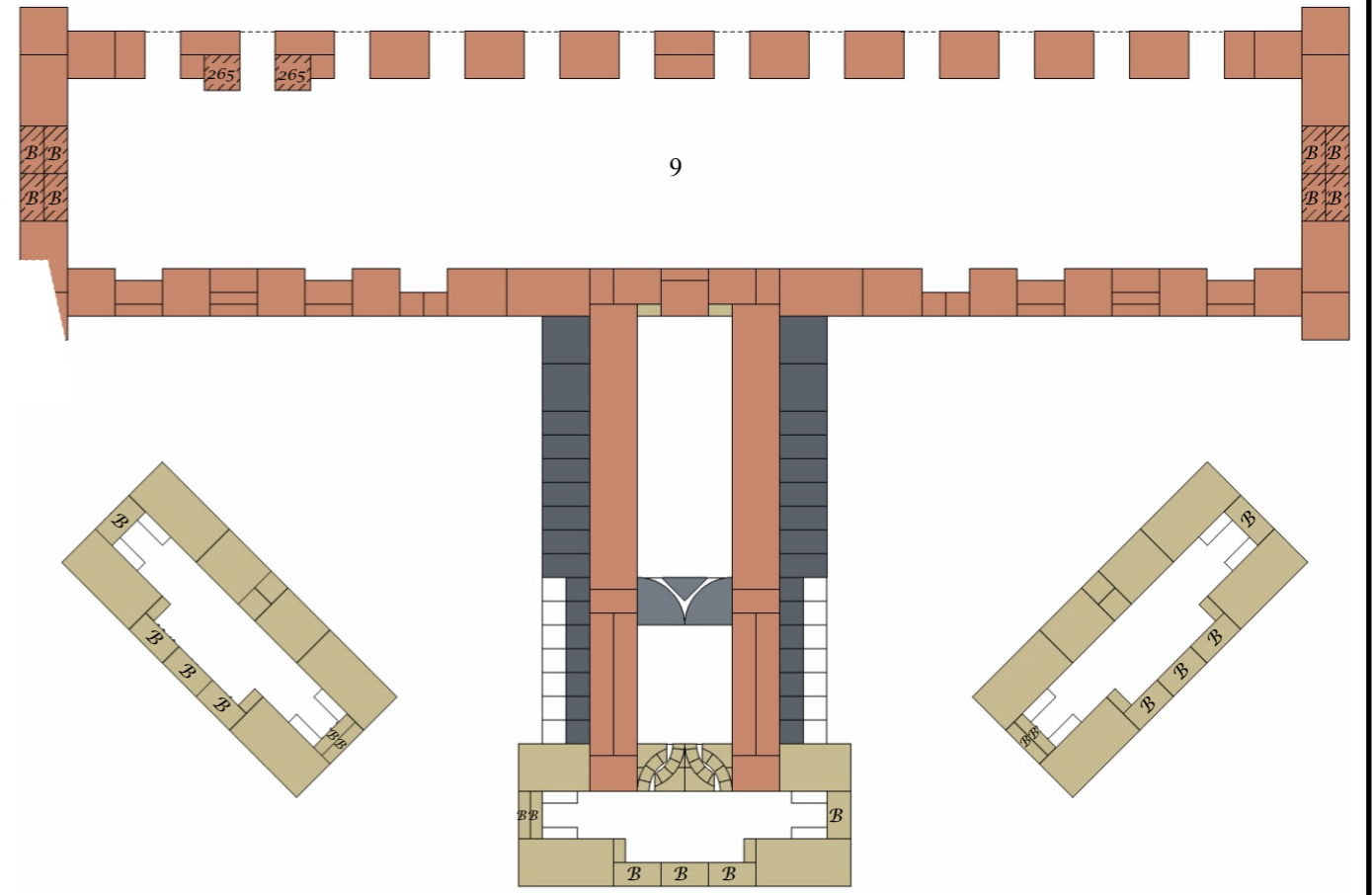
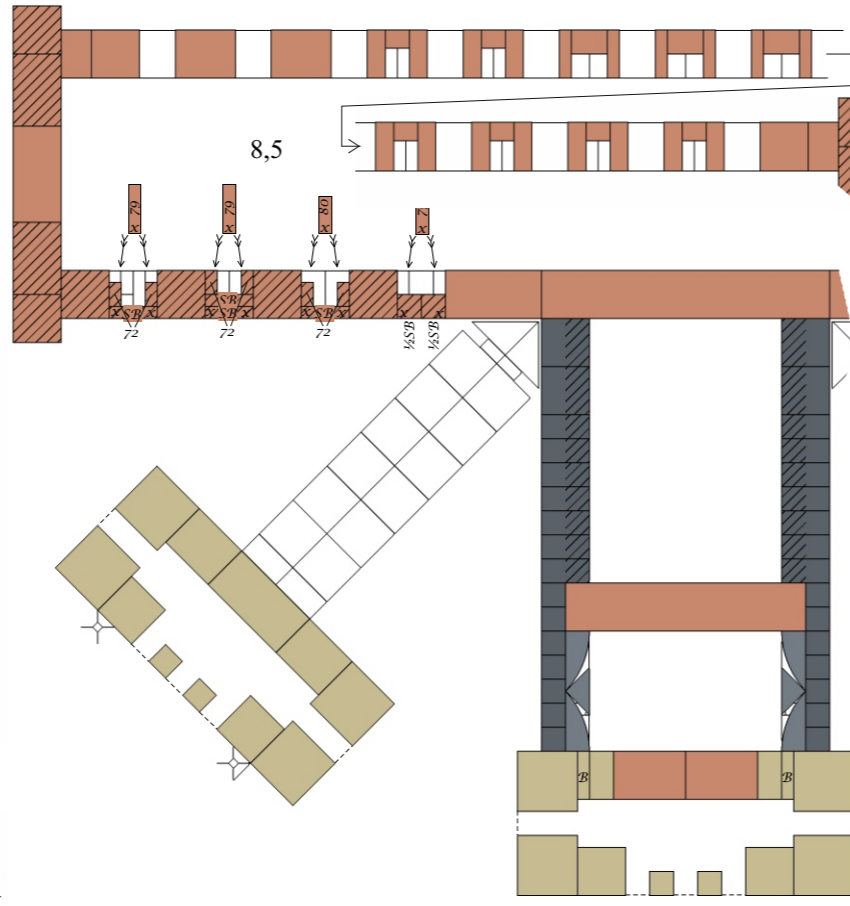
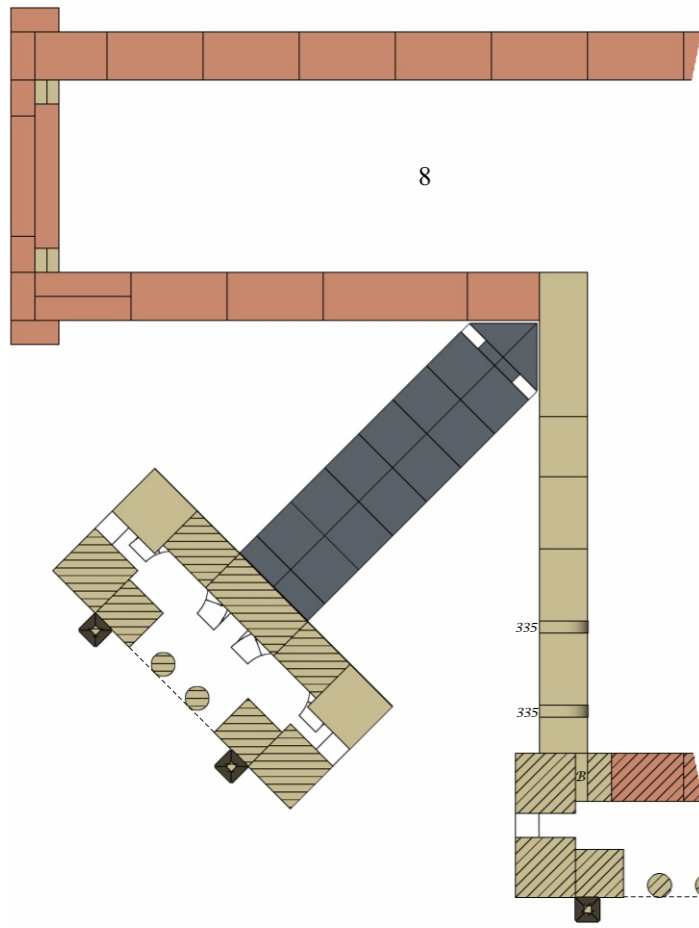
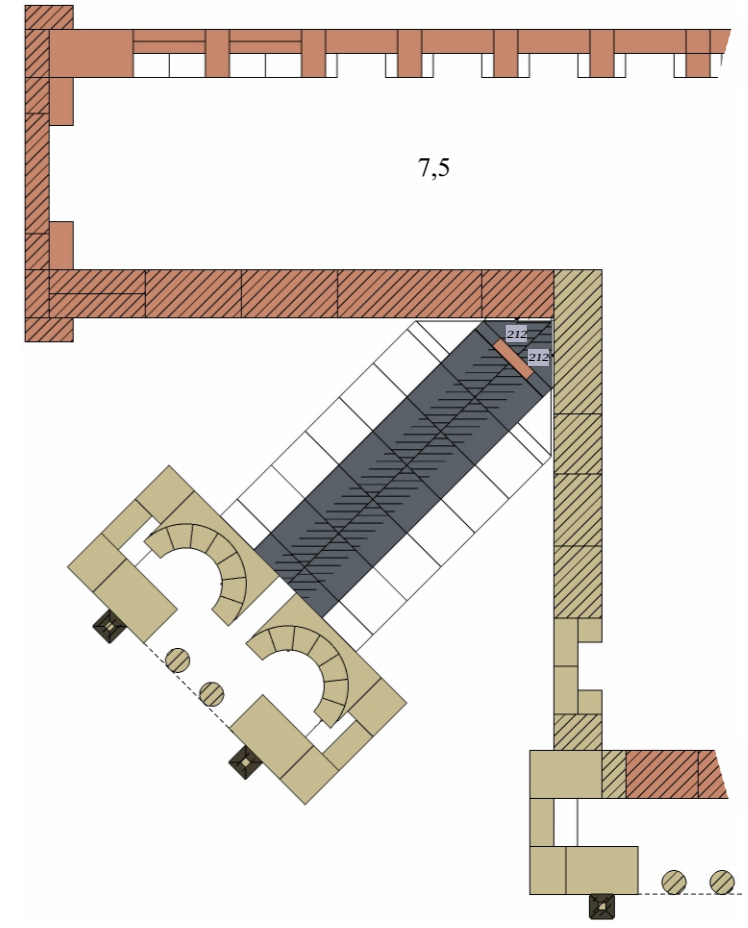
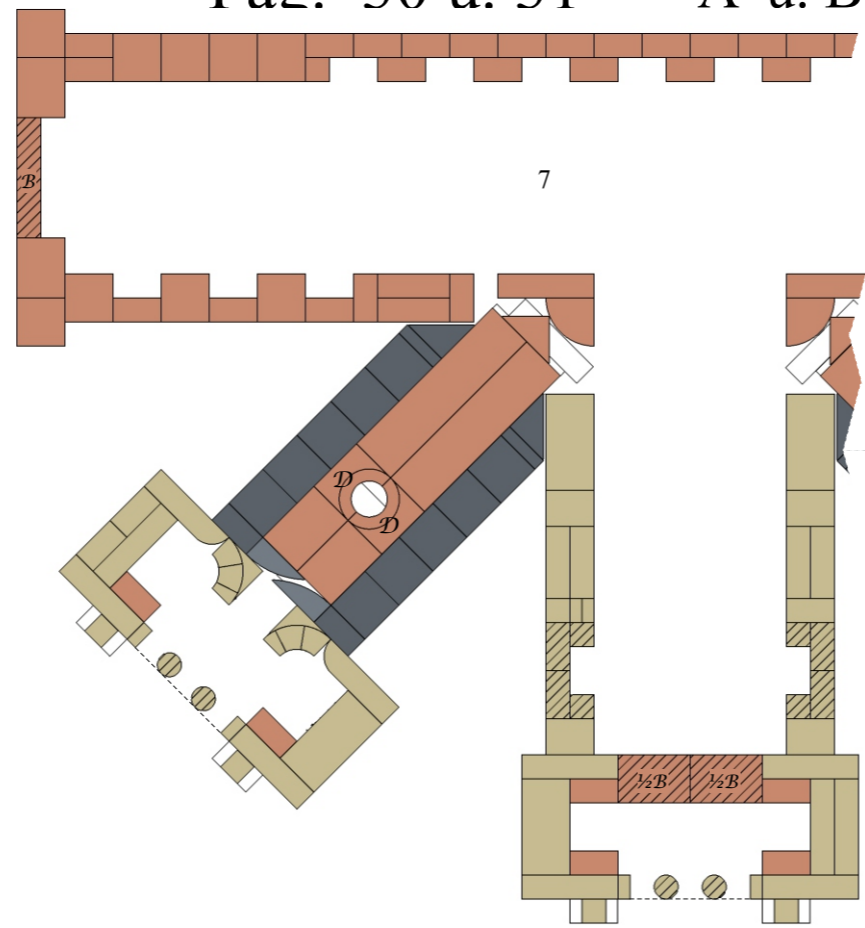
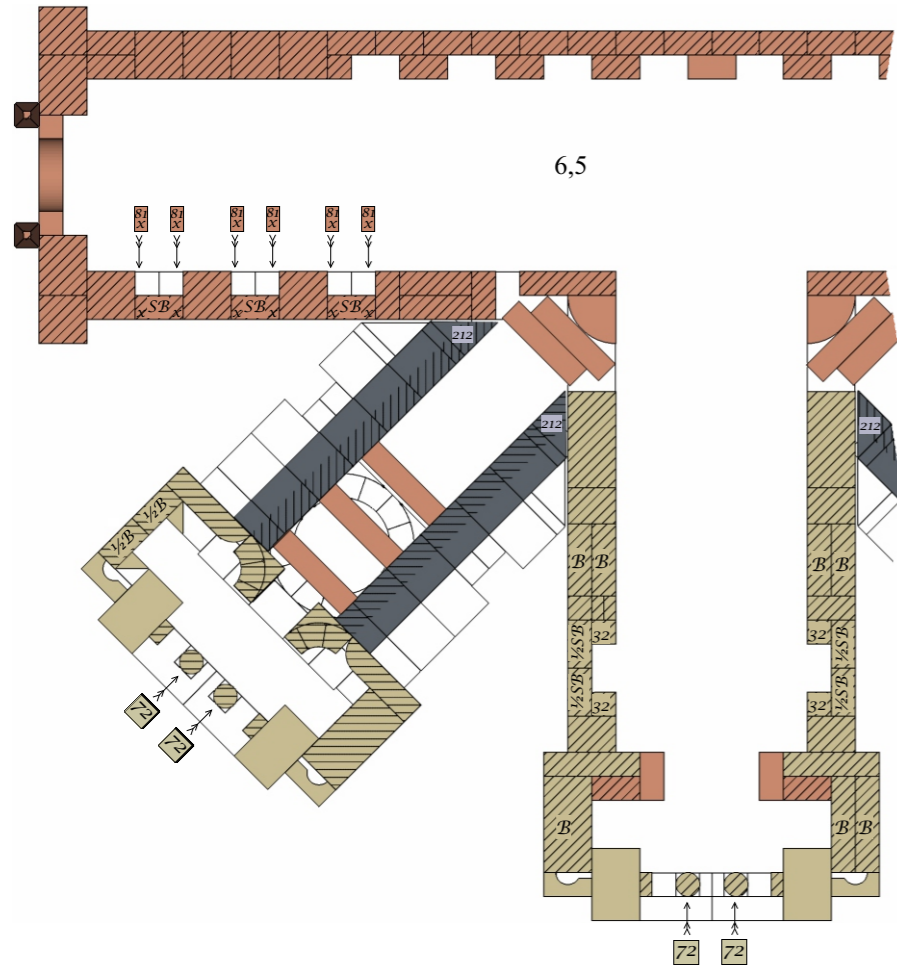

N^o 32.

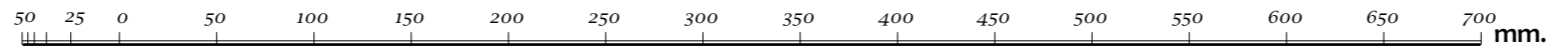

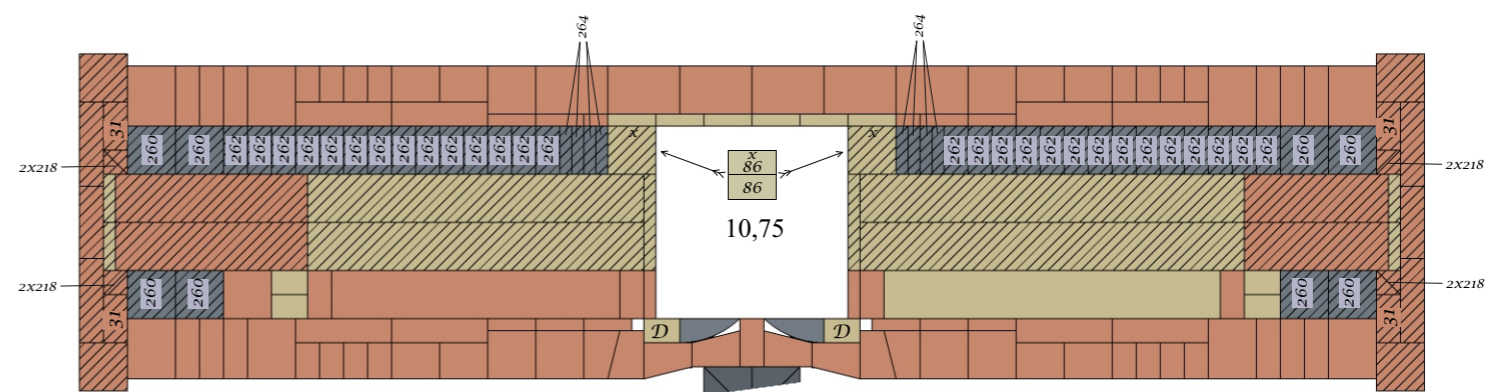
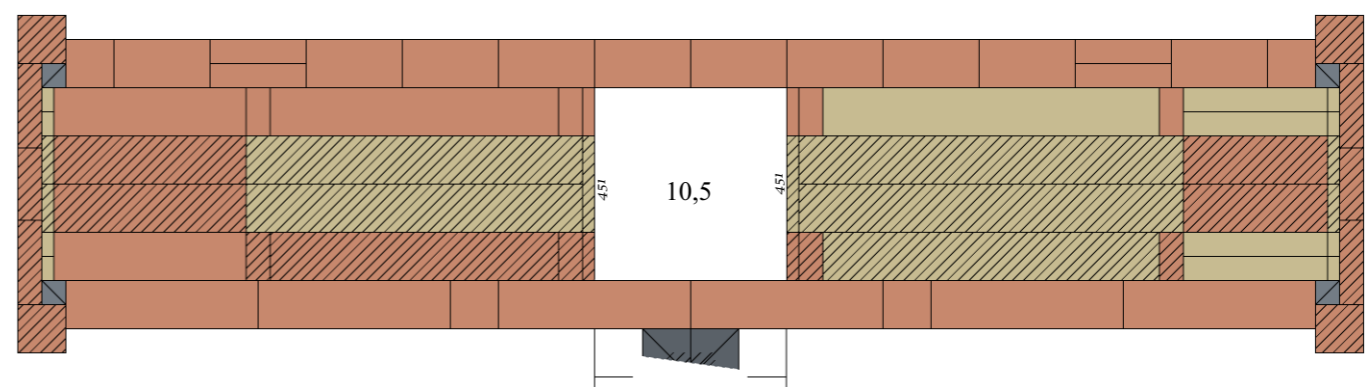
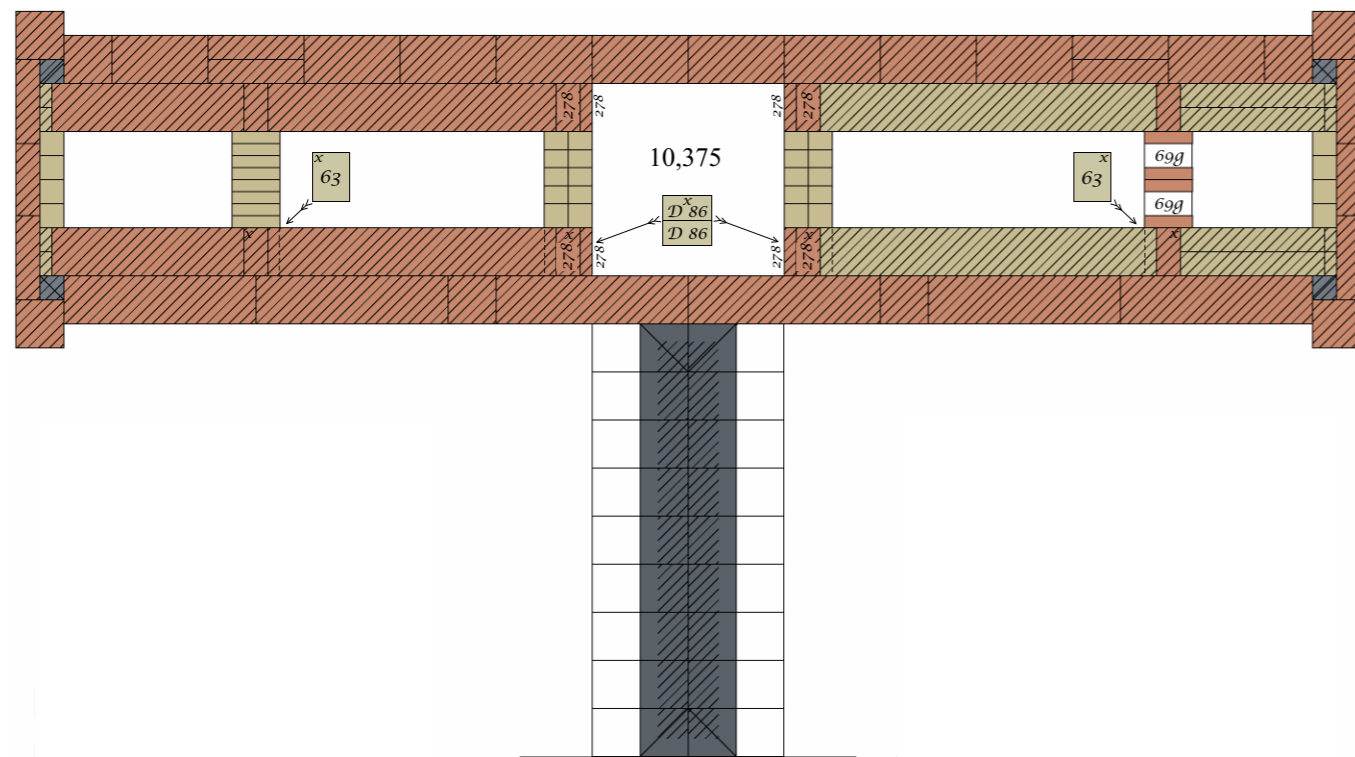
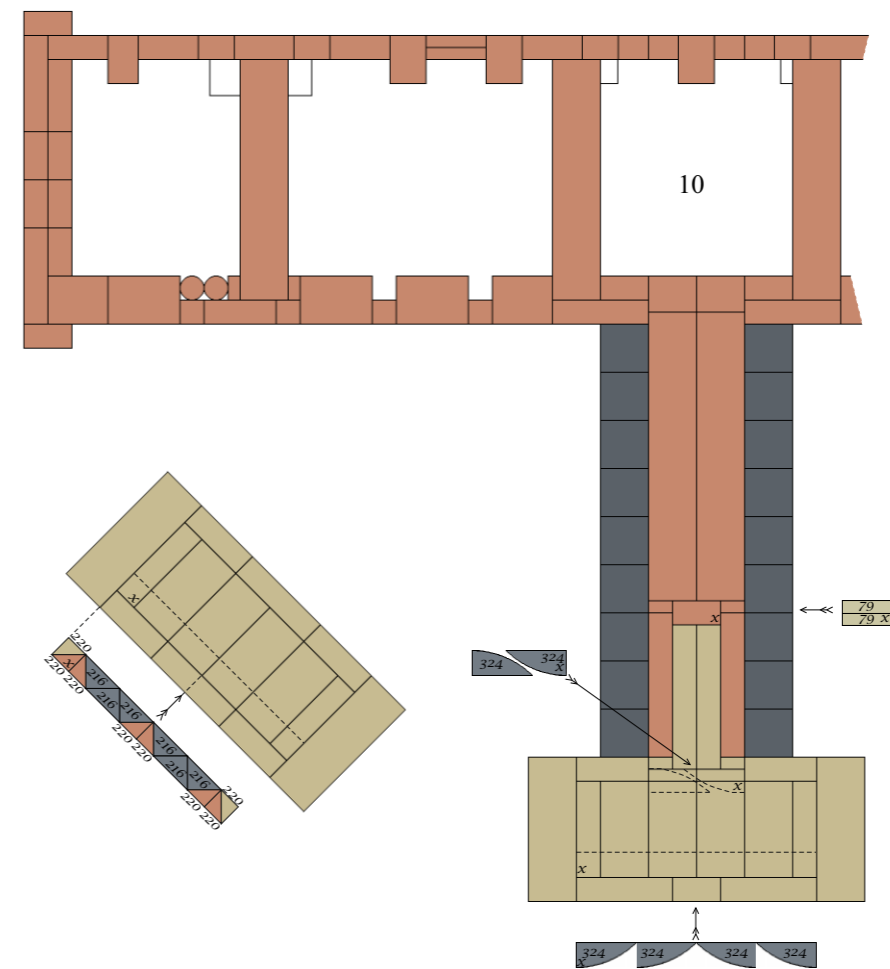
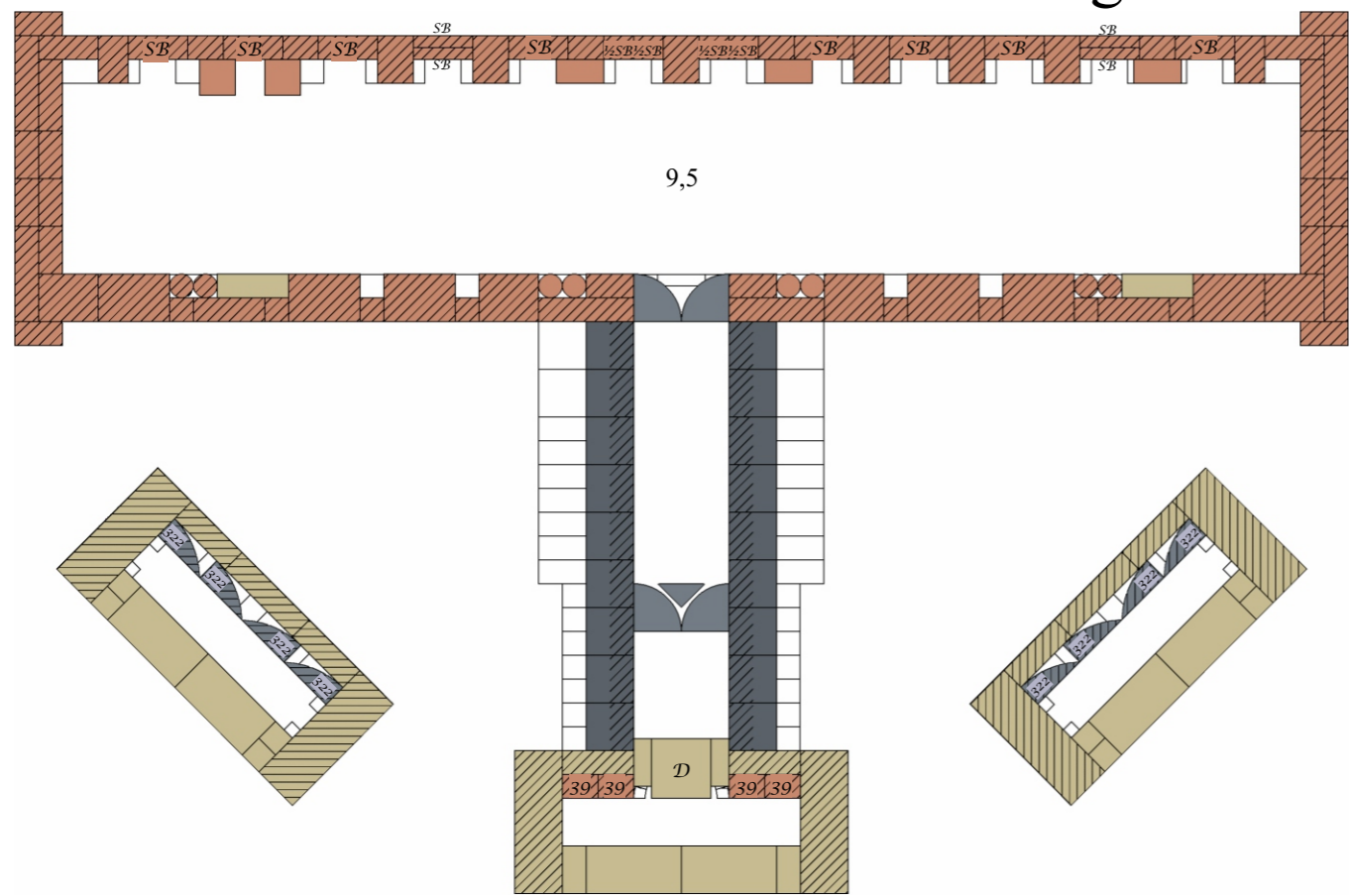

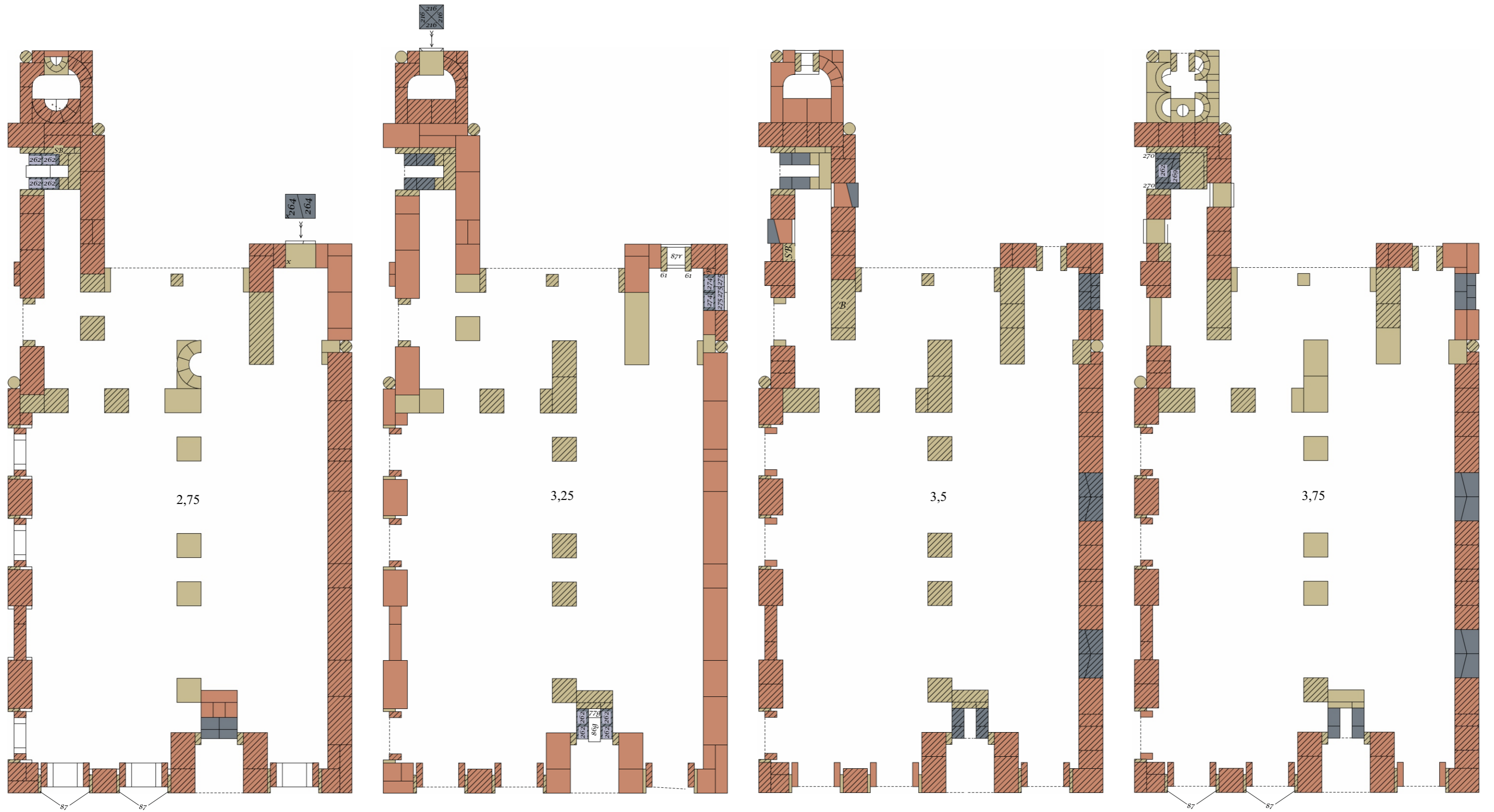

N^o 32.

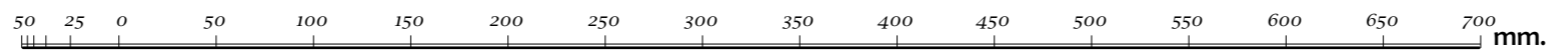

I-38

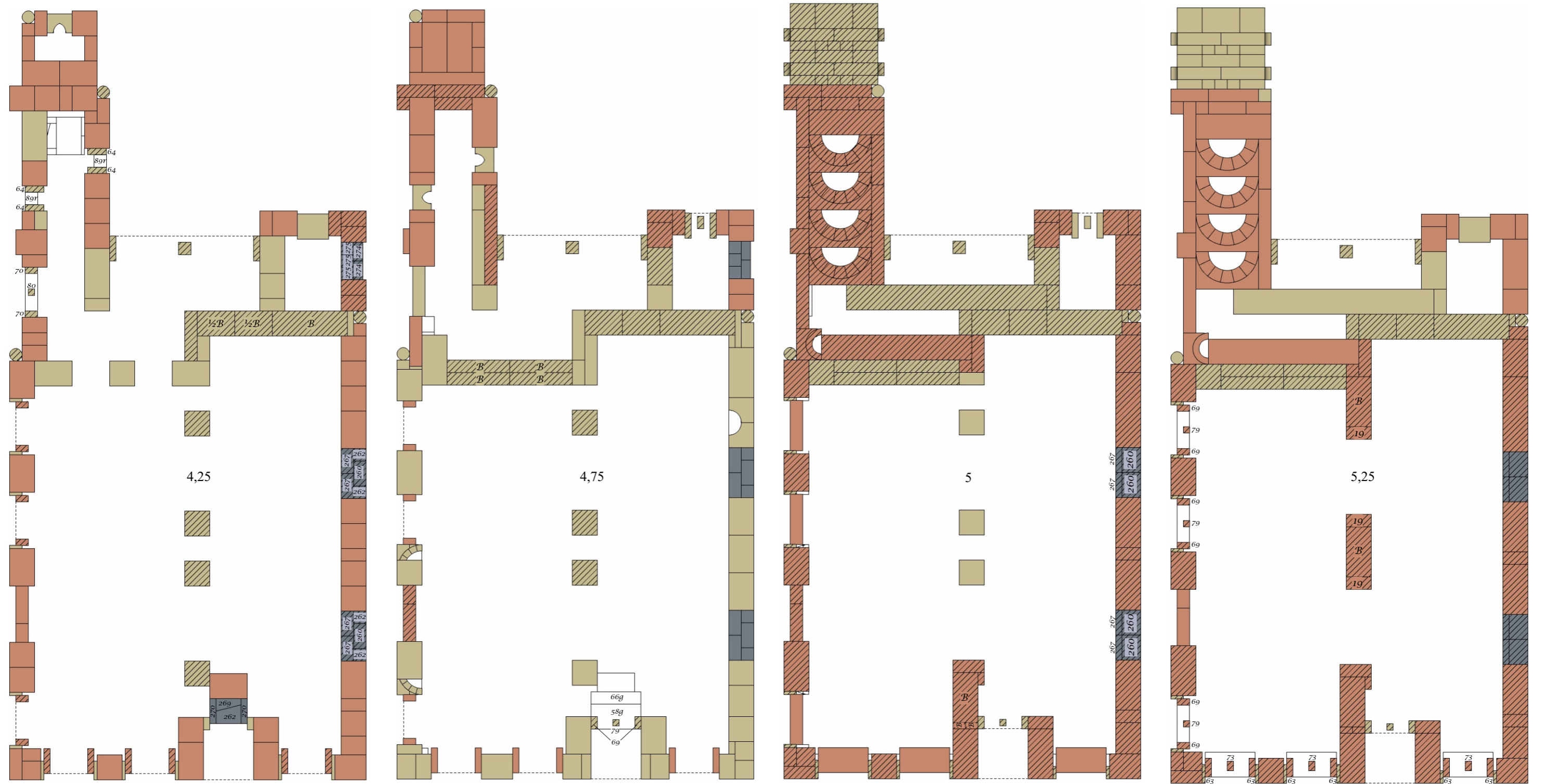

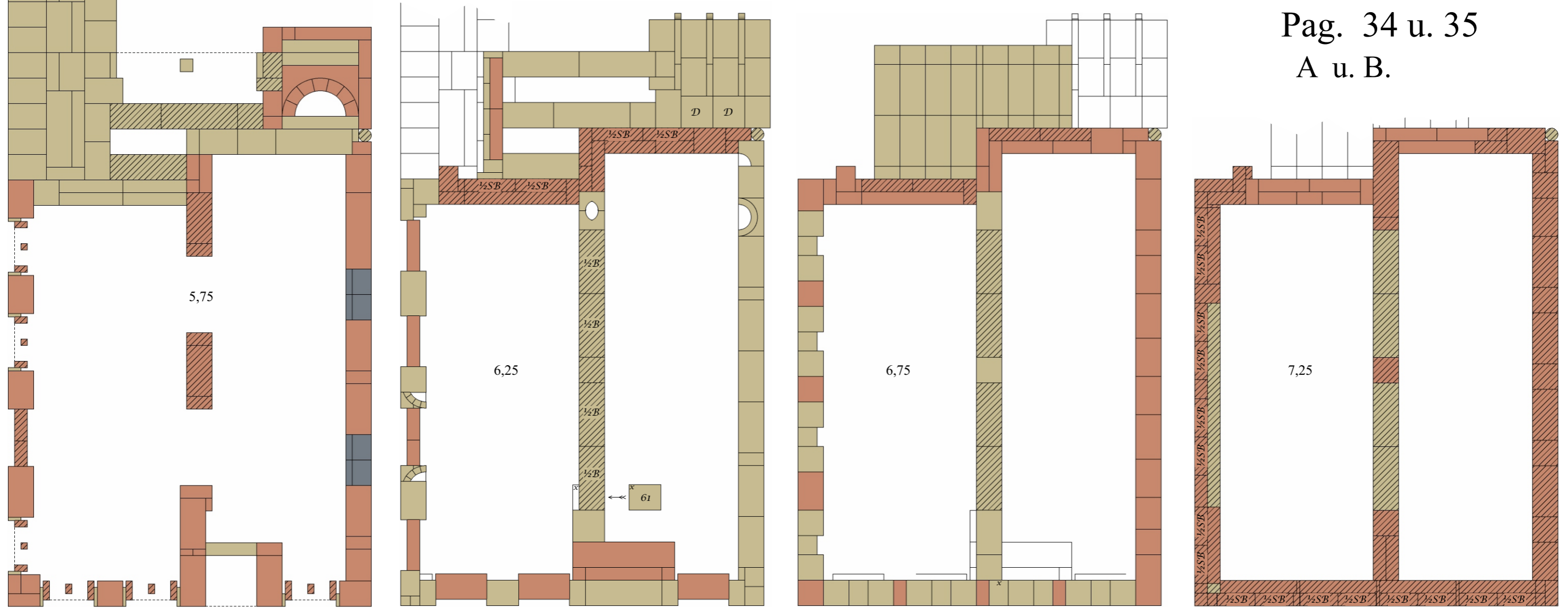
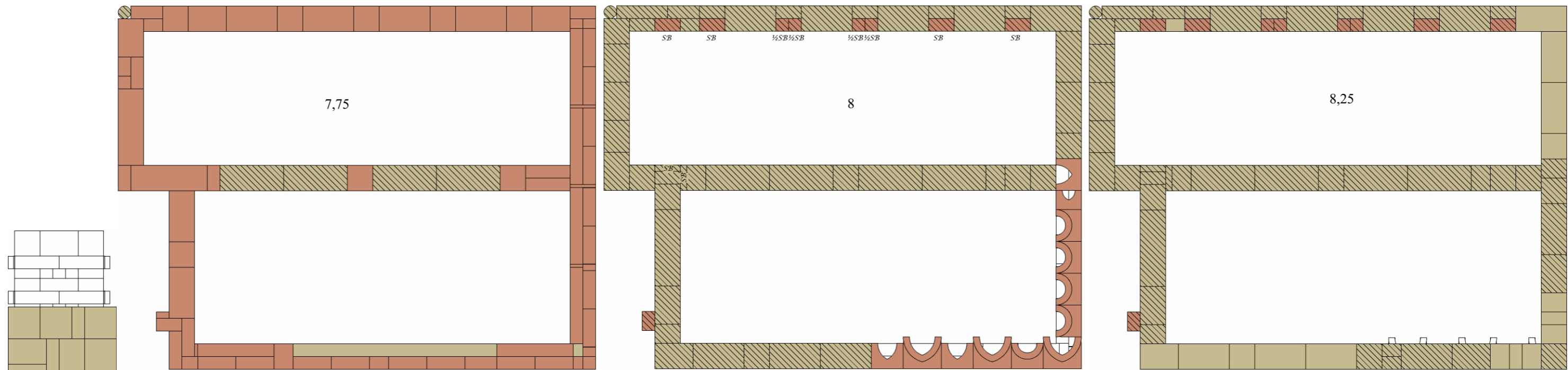

Pag. 34 u. 35
A u. B.

N^o 32.

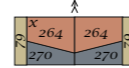
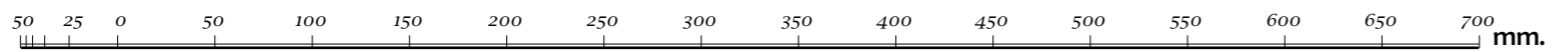

I-40

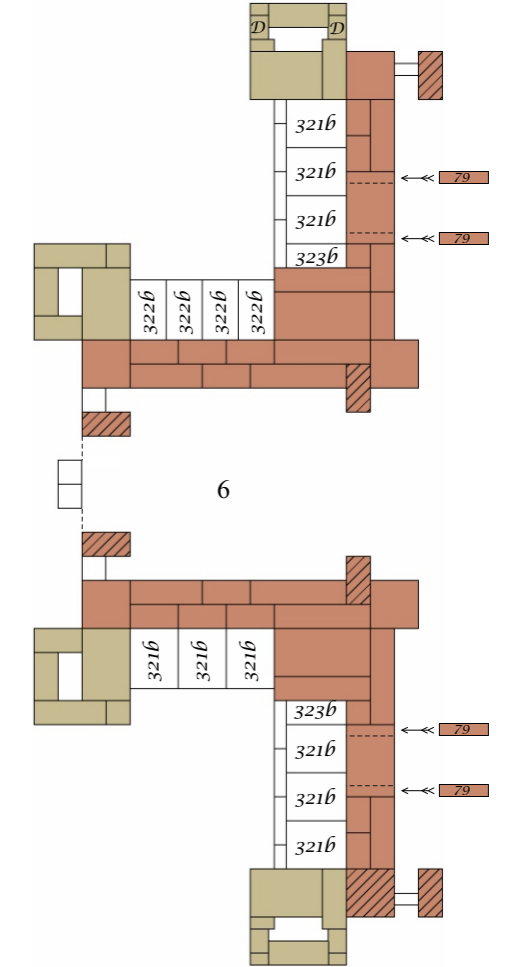
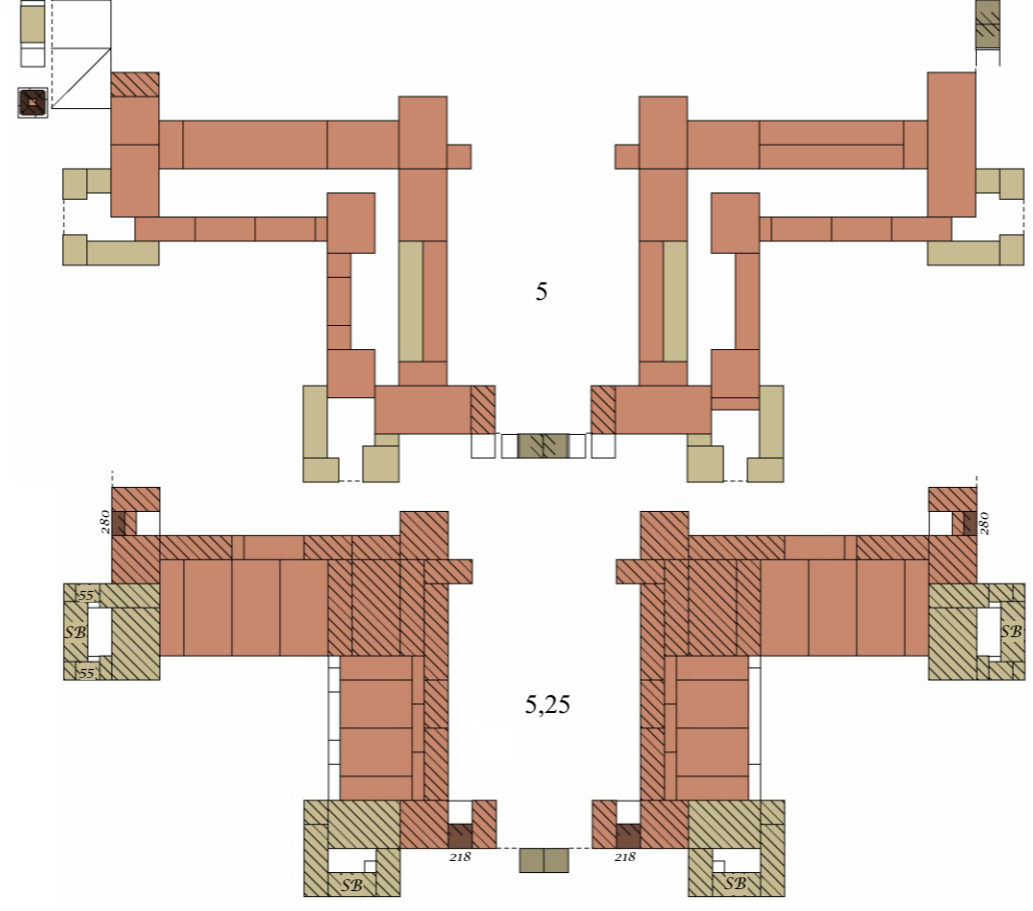
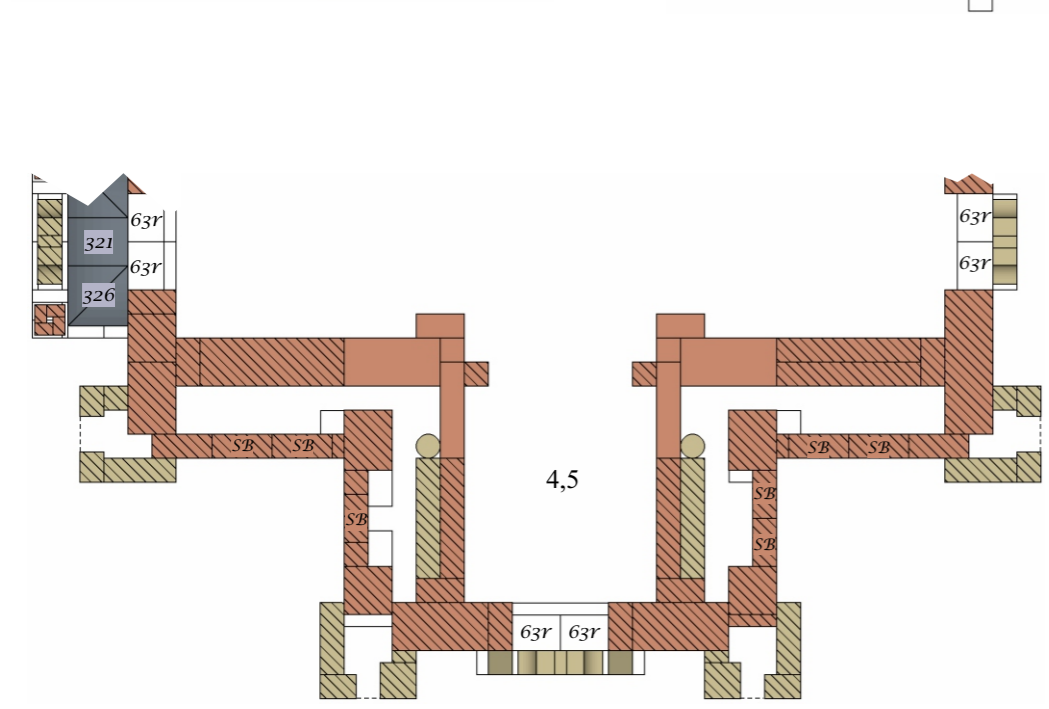
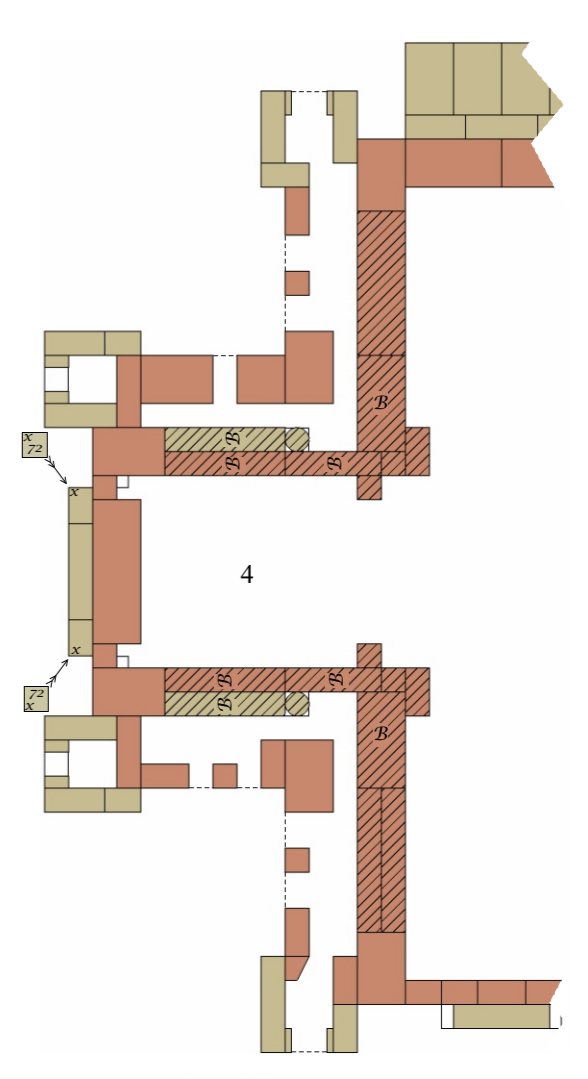
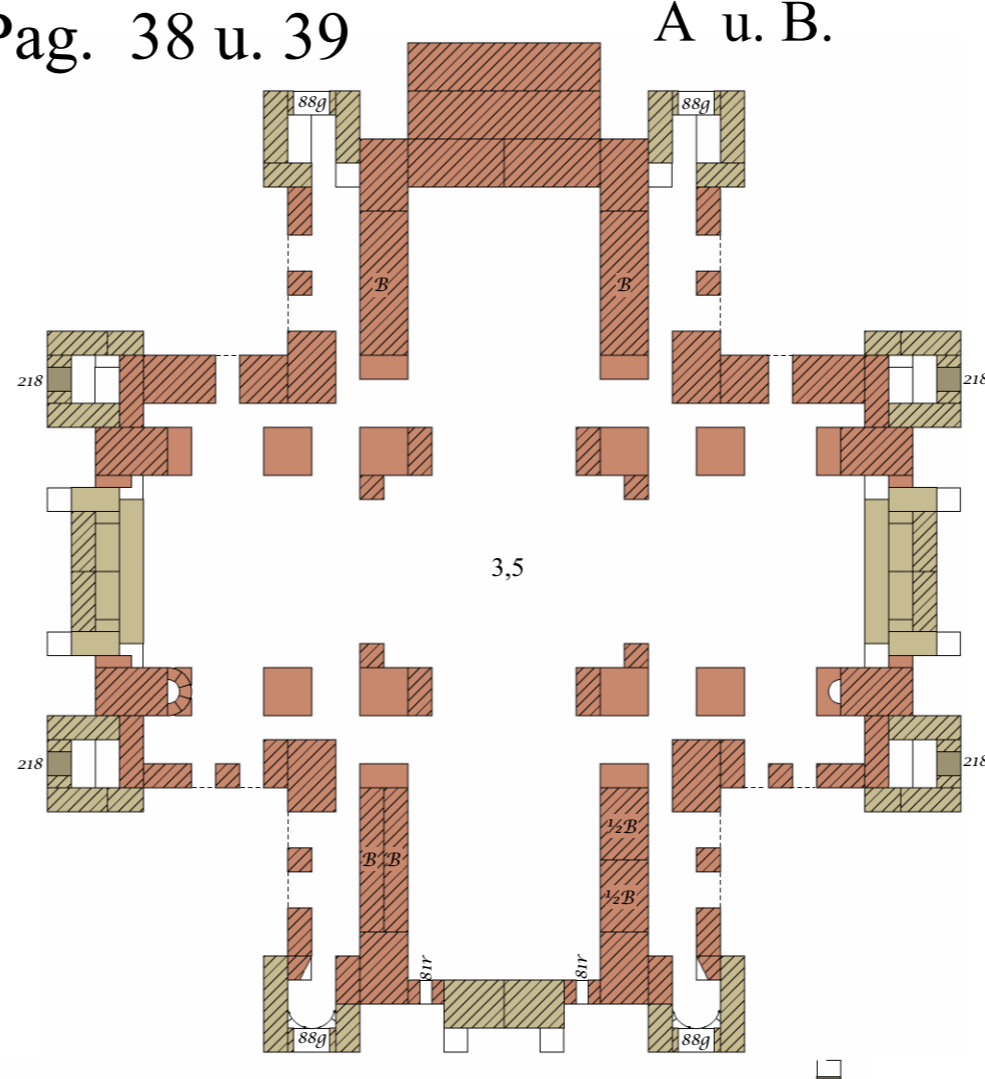
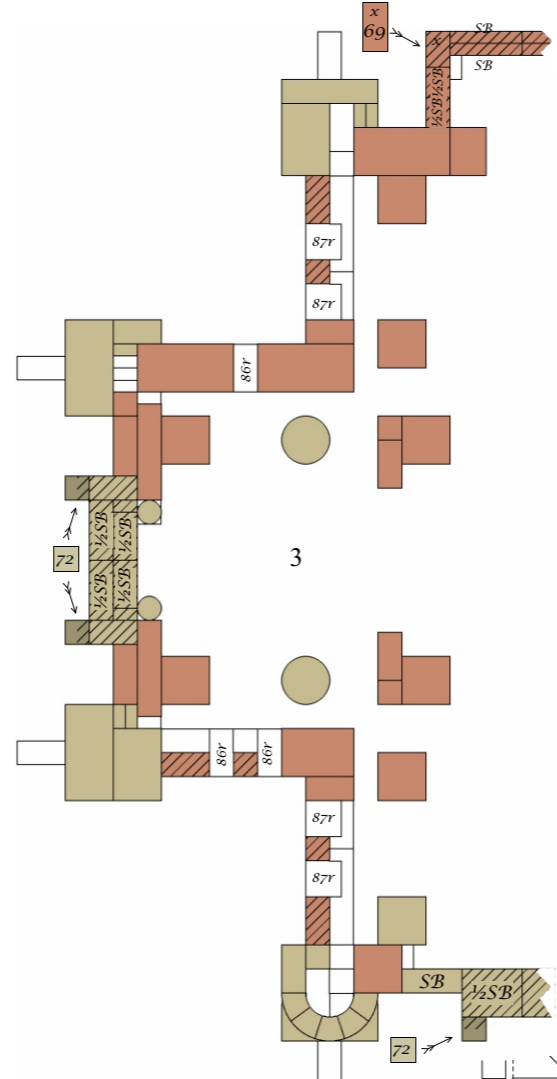
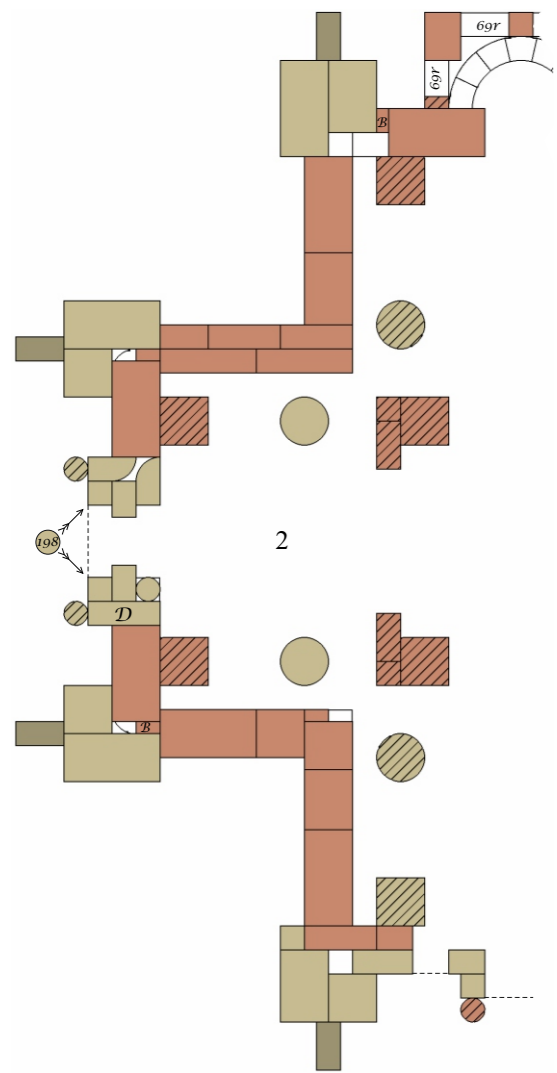

N^o 32.

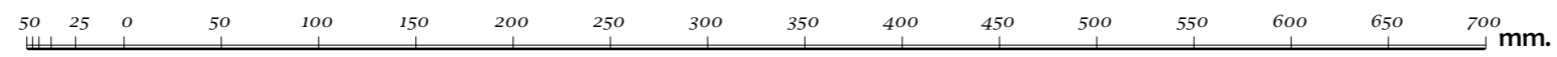

I-43

Pag. 38 u. 39
A u. B.

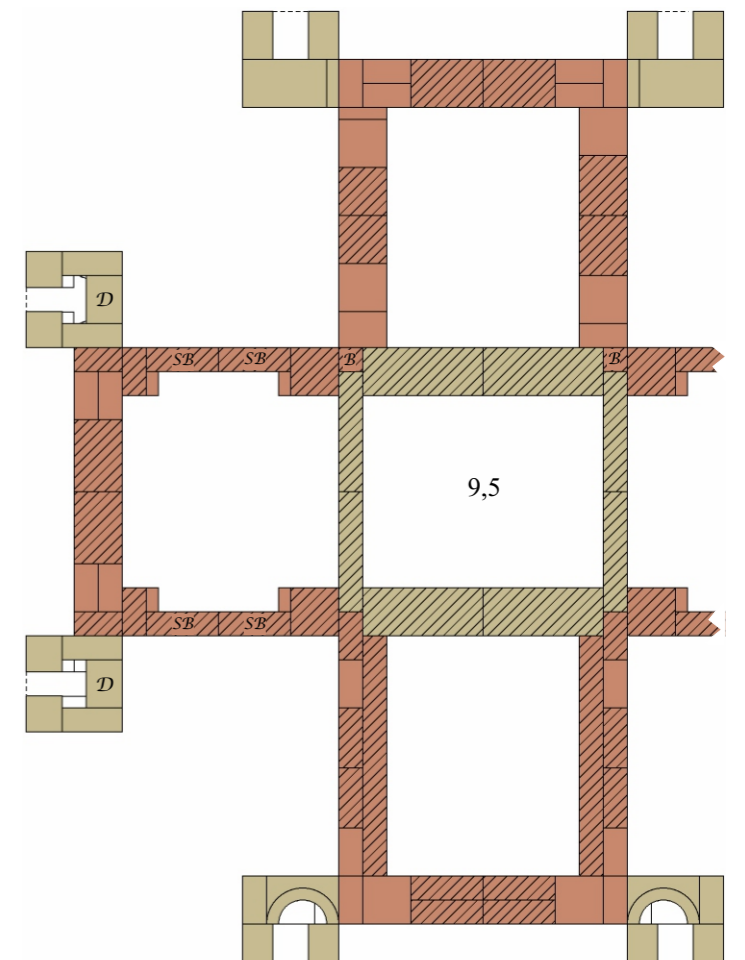
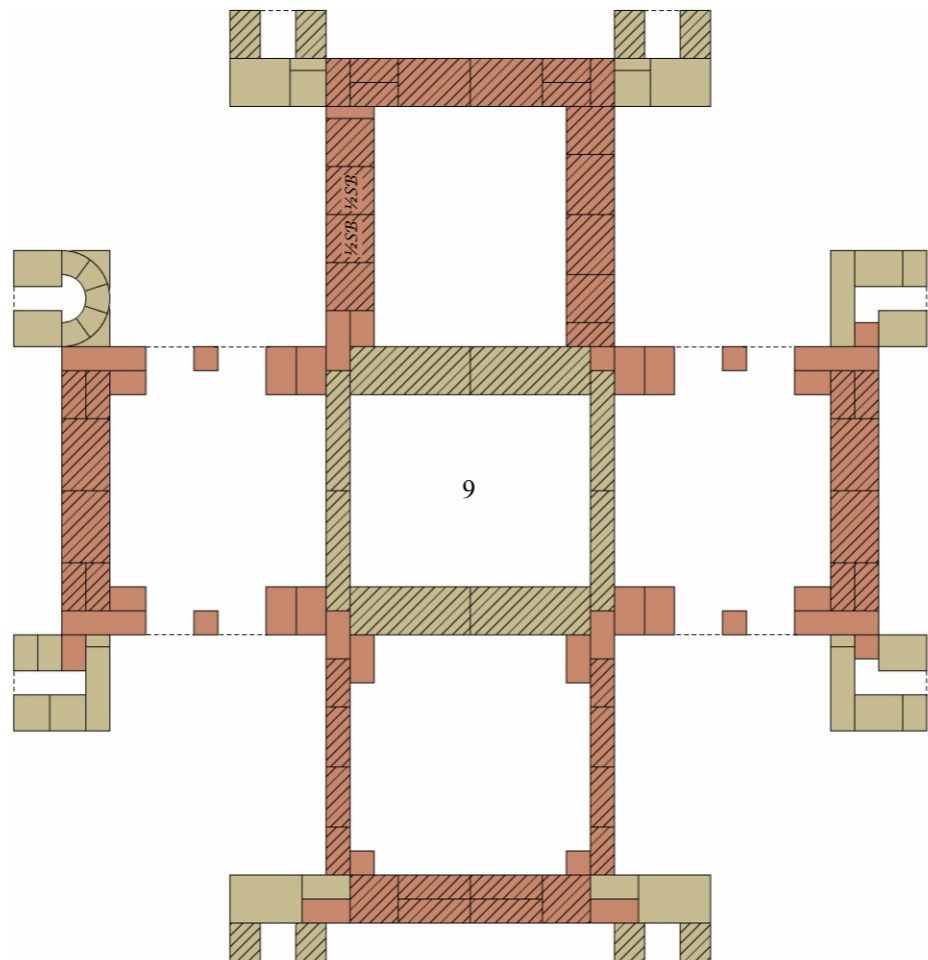
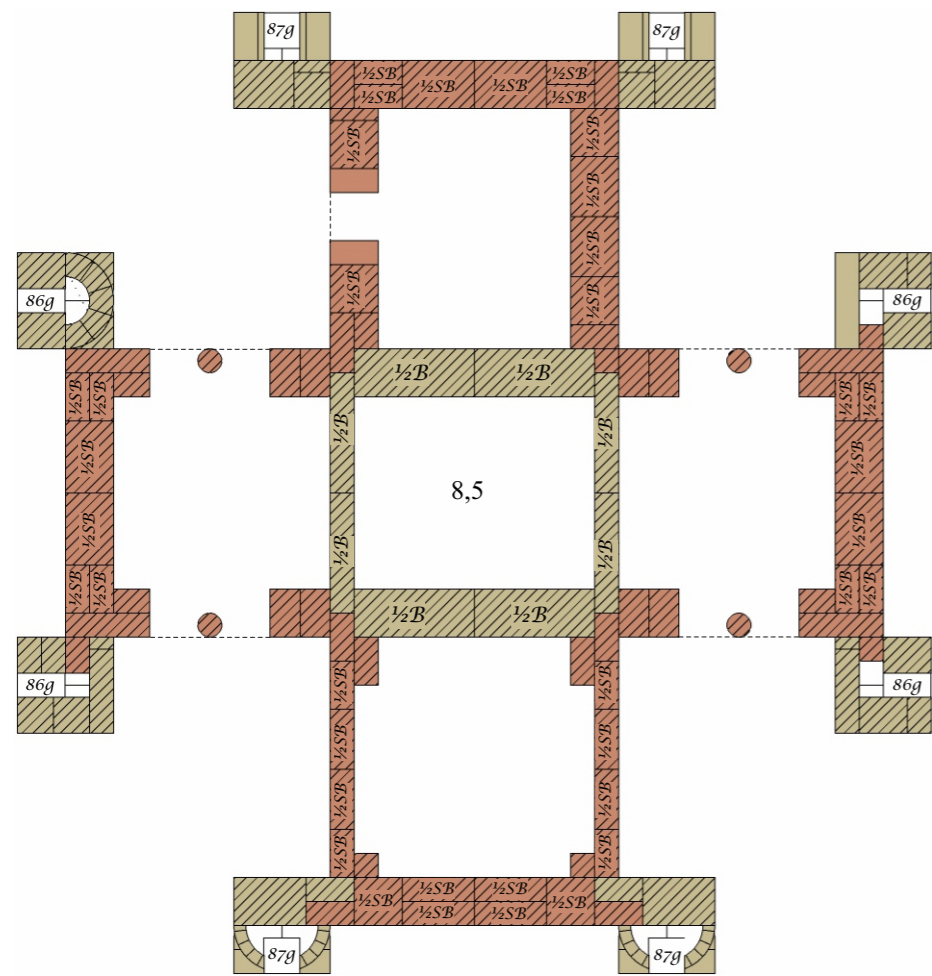
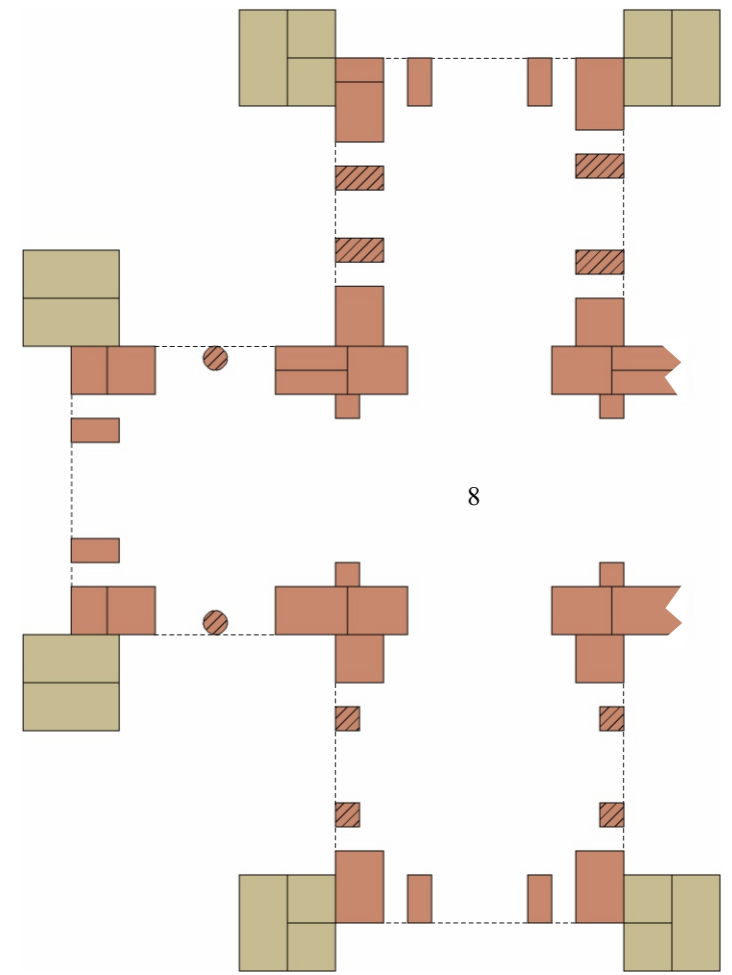
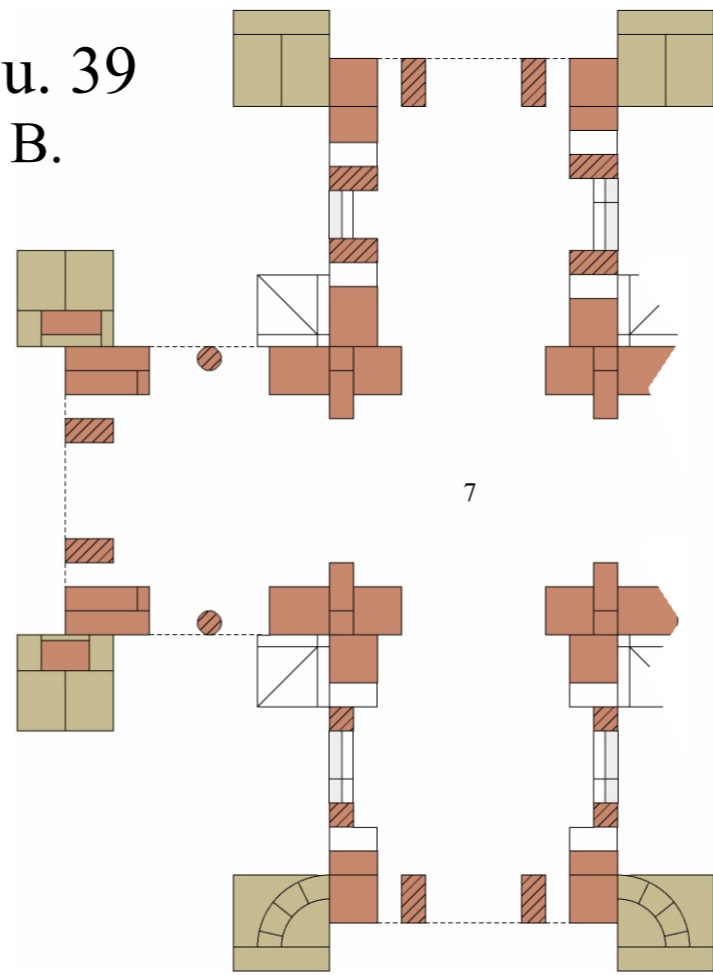
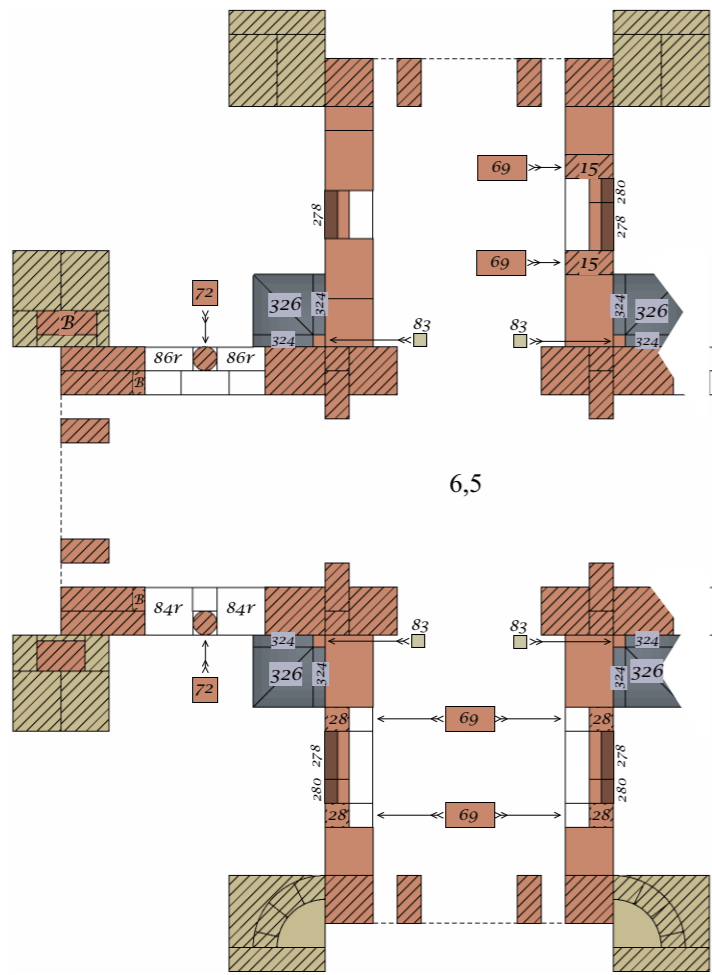

N^o 32.

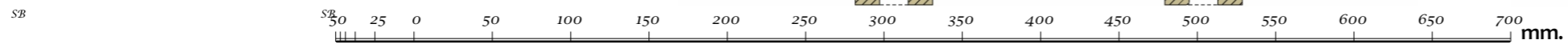

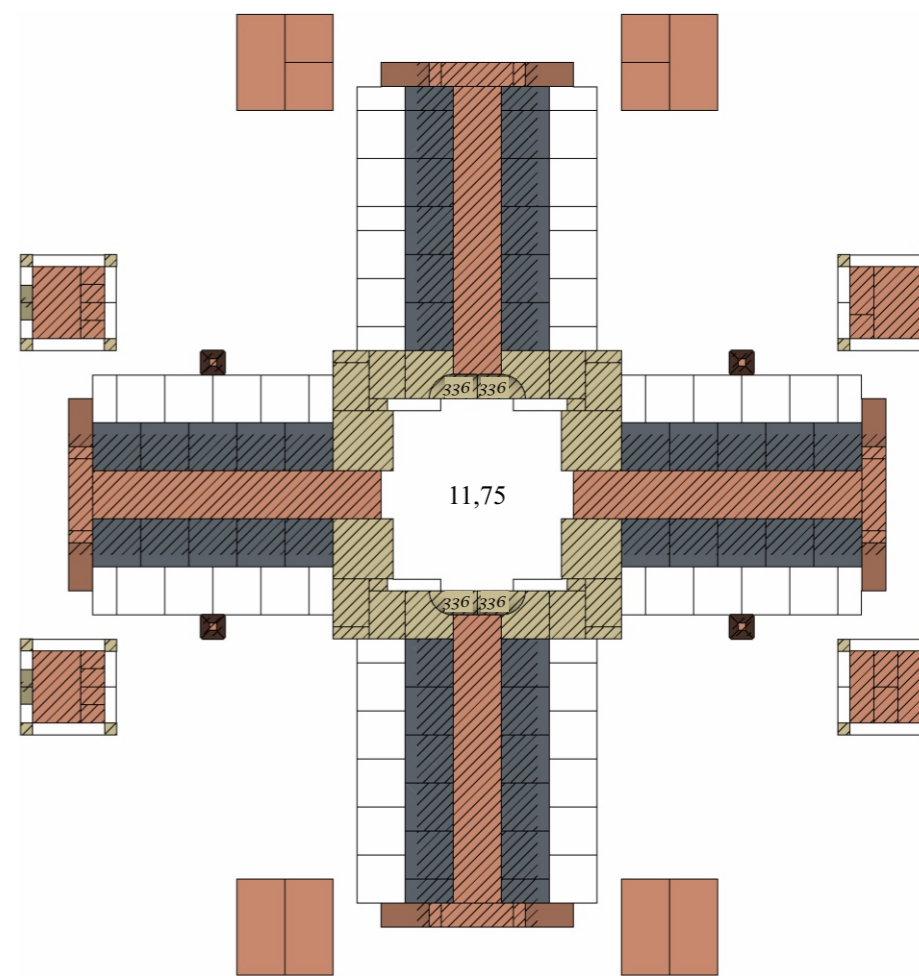
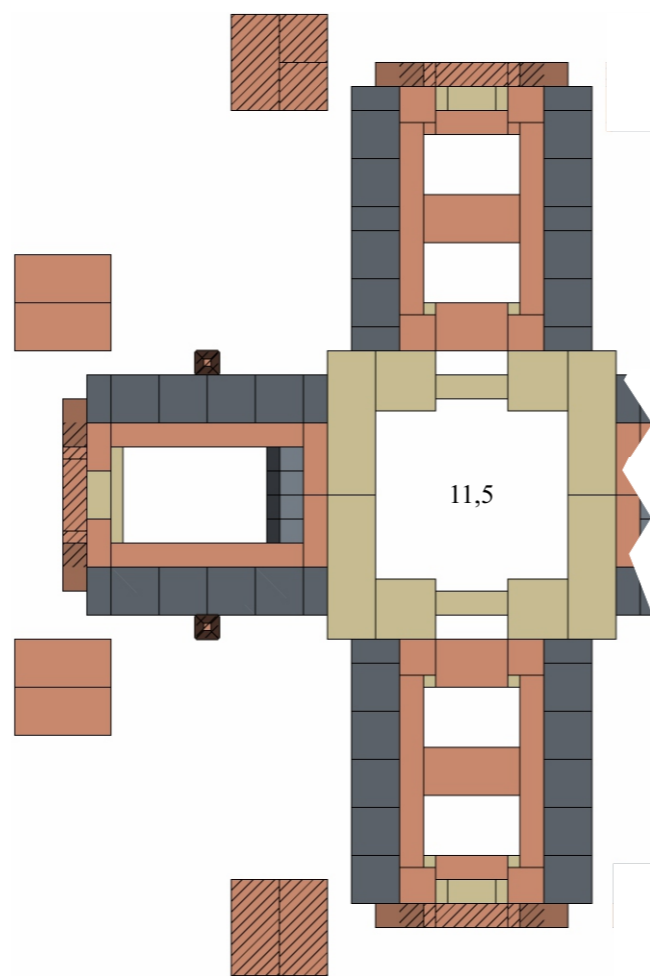
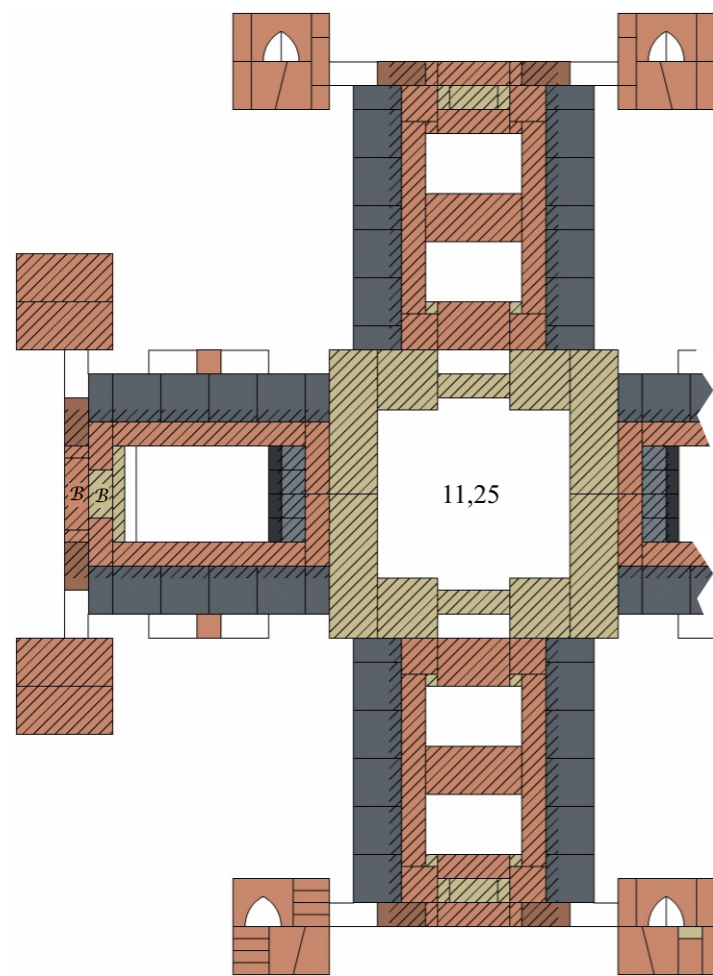
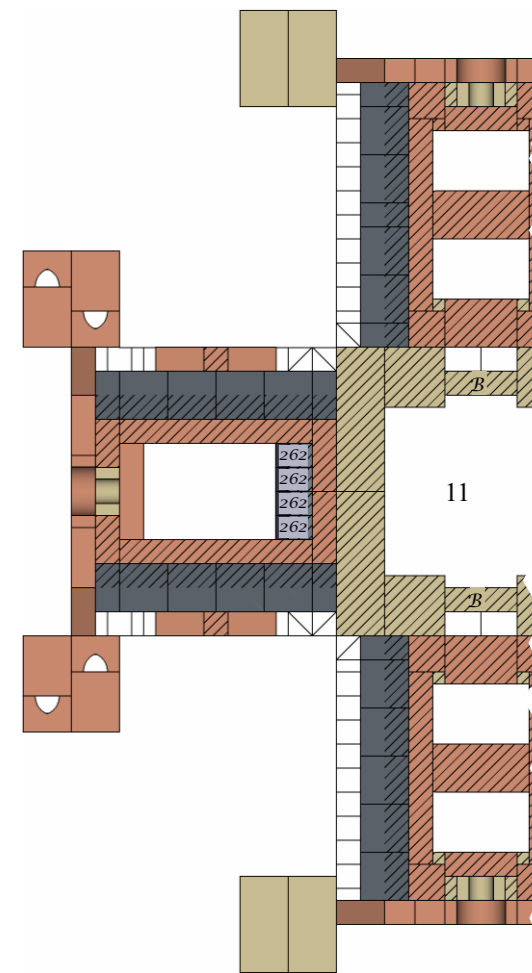
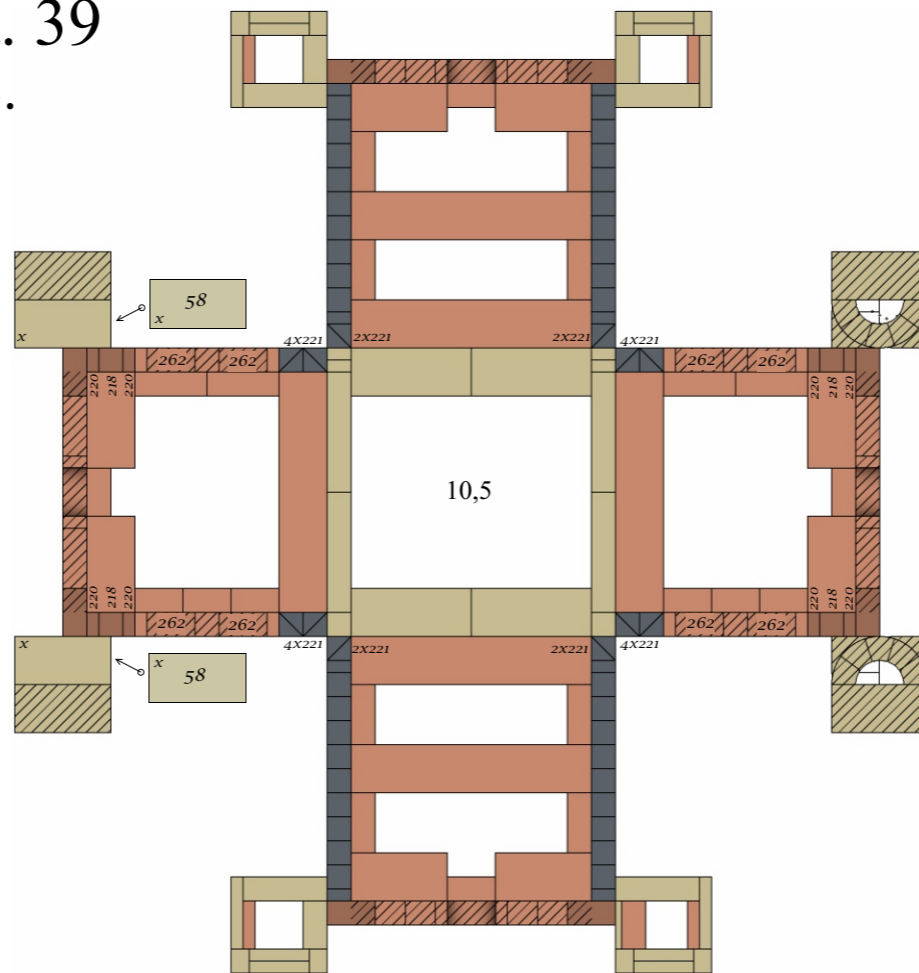
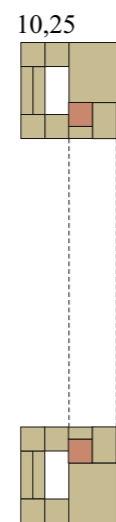
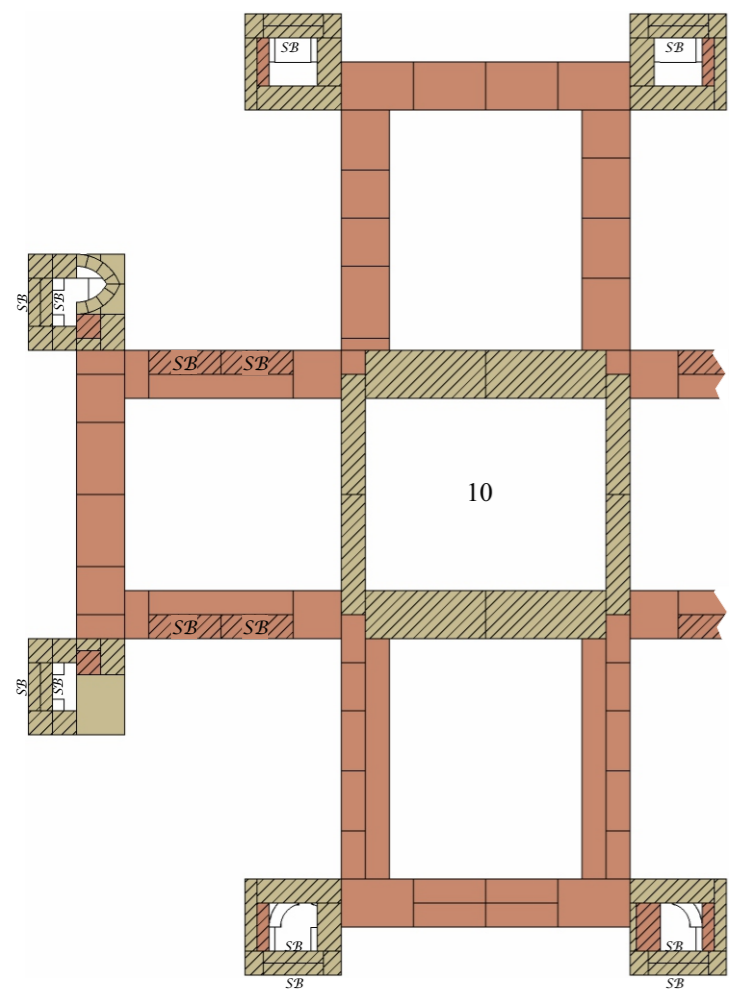

N^o 32.

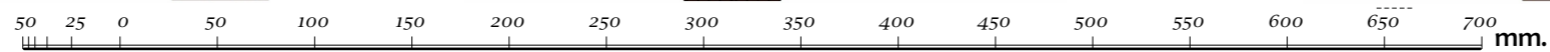

I-45

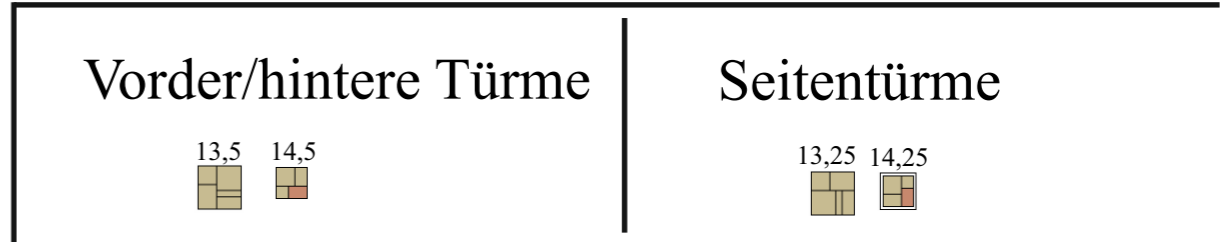
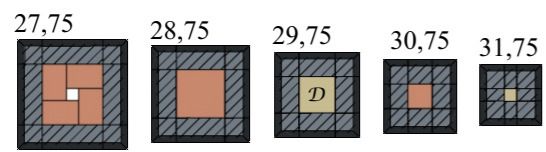
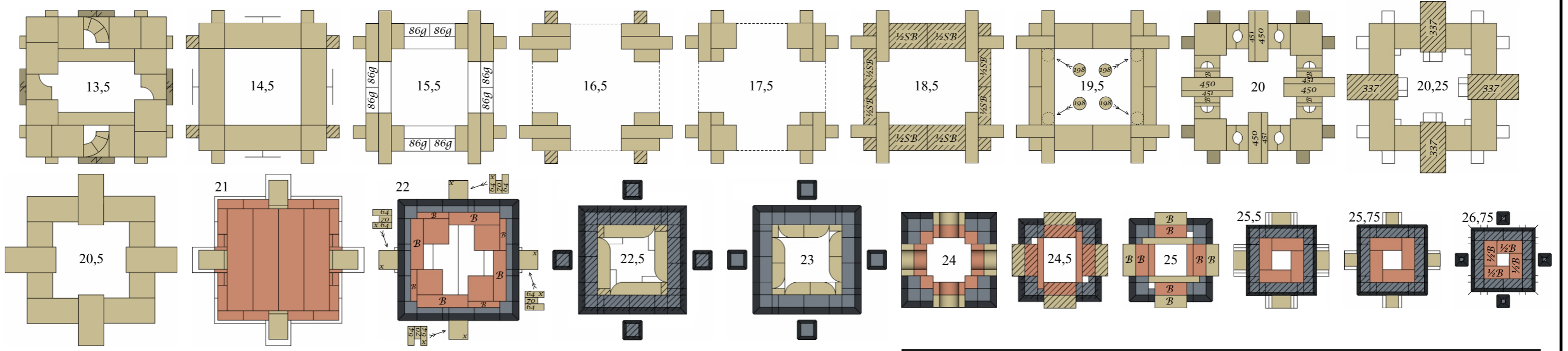
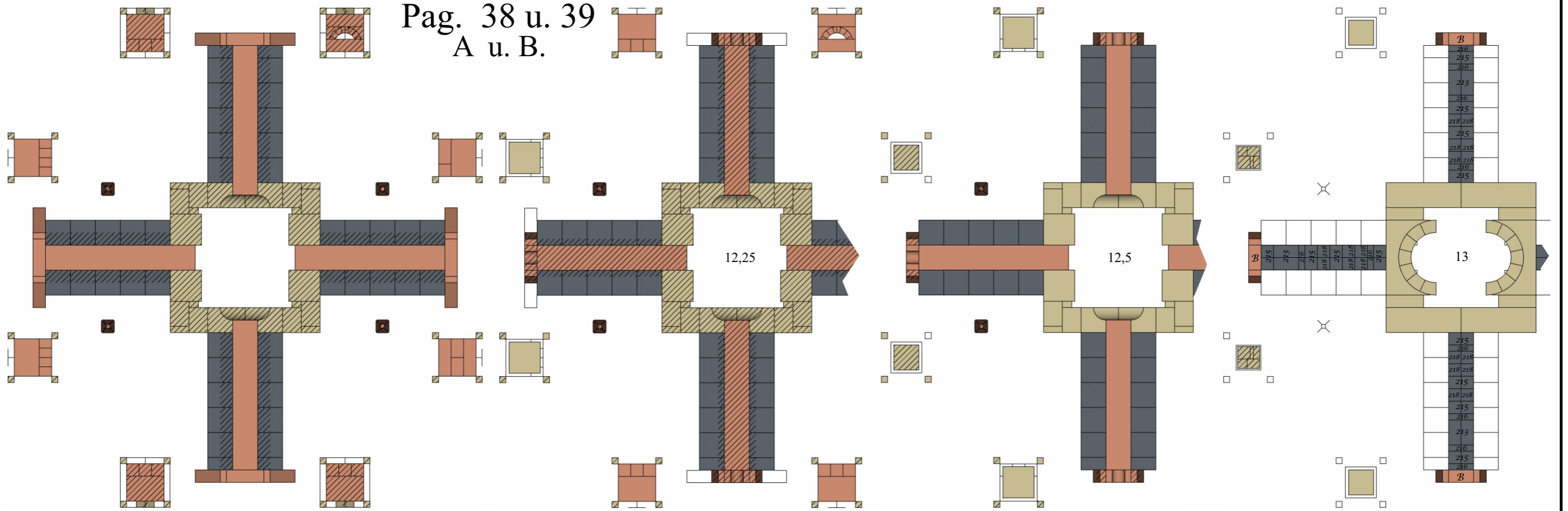

Pag. 38 u. 39
A u. B.



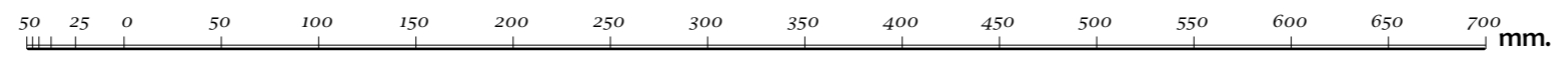

N^o 32.

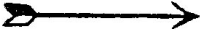



I-46

When using the sections of the present book please observe that every stone passing over the secants is hatched, and that the mark *D* means that here are two stones of equal size placed one above the other. The mark *B* denotes that here is to be placed an arch. The mark $\frac{1}{2}B$ means that here is to be placed a half arch. The mark *SB* means a pointed arch, and $\frac{1}{2}SB$ a pointed half arch. This mark  on the partial sections indicates that the stones of that partial section are to be put *underneath* the stones of the principal section, at the spot to which the arrow points. The mark  means that these stones are to be placed *above* the stones of the principal section. Single stones marked with small crosses or numbers refer to stones bearing the same marks or numbers. The marks Pag. 1, Pag. 2 &c. refer to those pages of the book on which the whole building is shewn.

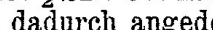
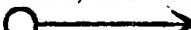

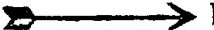
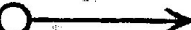
En se servant des coupes horizontales du présent cahier, on voudra observer ce qui suit. Toute pierre qui dépasse la ligne d'intersection, porte des hachures noires. La majuscule *D* signifie: Ici deux pierres pareilles se trouvent superposées, le signe *B* indique: Ici, il y a un arceau, ou $\frac{1}{2}B$, un demi-arceau, enfin le signe *SB*: Ici, se trouve une ogive, ou $\frac{1}{2}SB$: une demi-ogive. Si une coupe partielle est accompagnée du signe  c'est que, à l'endroit désigné par la flèche, ses pierres se trouvent sous celles de la coupe principale; au contraire, le signe  y est pour indiquer que les pierres de la coupe partielle se trouvent sur les pierres correspondantes de la coupe principale. Le but des petites croix et des numéros dont sont marquées certaines pierres dans quelques unes des coupes, c'est de renvoyer aux dessins isolés de pierres portant la même marque. Les signes: Pag. 1, Pag. 2, etc. renvoient à la page du cahier de modèles contenant le dessin de la bâtisse en question.

Bei der Benutzung der Querschnitte dieses Heftes beachte man, daß alle über die Schnittlinie hinausragenden Steine schwarz gestrichelt sind und daß das Zeichen *D* bedeutet: hier liegen zwei gleiche Steine übereinander, das Zeichen *B*: hier liegt ein Bogen oder $\frac{1}{2}B$: ein halber Bogen und *SB*: hier liegt ein Spitzbogen oder $\frac{1}{2}SB$: ein halber Spitzbogen. Steht bei den Teilschnitten das Zeichen  so wird dadurch angedeutet, daß die Steine des Teilschnittes an der Stelle, auf die der Pfeil hinzeigt, unter den Steinen des Hauptschnittes liegen, durch das Zeichen  wird dagegen angedeutet, daß die Steine auf den betreffenden Steinen des Hauptschnittes liegen. Sind bei einem Schnitt einzelne Steine mit Kreuzchen oder mit Nummern versehen, so soll damit auf Steine verwiesen werden, die das gleiche Zeichen oder dieselbe Nummer tragen. Durch die Zeichen: Pag. 1, Pag. 2 usw. wird auf die Seite des Vorlageheftes verwiesen, auf der sich die Abbildung des betreffenden Baues befindet.

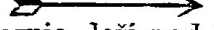
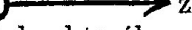

Bij gebruikmaking van de doorsneden dezer aflevering gelieve men het volgende niet uit het oog te verliezen. Alle steenen, die boven de snijlijn uitsteken, zijn zwart gestreept. Het teeken *D* beduidt: Hier liggen twee gelijke steenen op elkander, *B* hier ligt een boog, $\frac{1}{2}B$: een halve boog, en *SB*: hier ligt een spitsboog of $\frac{1}{2}SB$: een halve spitsboog. Het teeken  bij de deelsneden geeft te kennen, dat de steenen van de deelsnede, op de plaats door den pijl aangewezen, onder de steenen van de hoofdsnede liggen; het teeken  duidt daarentegen aan, dat die steenen op de betrokken steenen der hoofdsnede liggen. Zijn in eene doorsnede enkele steenen van kruisjes of nummers voorzien, dan wordt daardoor verwezen naar de steenteekening, die het zelfde teeken of nummer draagt. De teekens: Pag. 1, Pag. 2 enz. verwijzen naar de bladzijde der voorbeeldenaflevering, waarop zich de teekening van het betrokken gebouw bevindt.

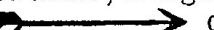

Ved Benyttelsen af Tværnsnittene i dette Hefte bør man give Agt paa, at alle de Stene, som rage ud over Snitlinien, ere sort skrafferede, og at Tegnet *D* betyder: her ligge to ens Stene ovenpaa hinanden, Tegnet *B*: her ligger en Bue eller $\frac{1}{2}B$: en halv Bue, og *SB*: her ligger en Spidsbue eller $\frac{1}{2}SB$: en halv Spidsbue. Staaer ved Delsnittene Tegnet  saa antydes det herved, at Delsnittets Stene ligge nedenunder Hovedsnitstenene paa det Sted, hvor Pilen henviser; ved Tegnet  antydes det derimod, at Stenene ligge ovenpaa de paagjeldende Hovedsnitstene. Ere i et Snit enkelte Stene forsynede med smaa Kryds eller med Nummere, saa henvises herved til de Stentegninger, som bære det samme Tegn eller samme Nummer. Ved Tegnene: Pag. 1, Pag. 2 osv. henvises til den Side i Forbilledheftet, paa hvilken Afbildningen af den paagjeldende Bygning befinder sig.

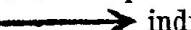
Při upotřebení příčných průřezů tohoto sešitu budíž toho dbáno, že všechny nad řeznou čarou vyčnívající kaménky jsou černě vyčárkovány, a že značí znaménko *D*: zde leží na sobě dva stejné kaménky, znaménko *B*: zde leží oblouk nebo $\frac{1}{2}B$: zde leží polooblouk a *SB*: zde leží na sobě dva stejné tický nebo $\frac{1}{2}SB$: polooblouk gotický. Nalézá-li se u dílného průřezu znaménko  tož se tím naznačuje, že kaménky dílného průřezu na tom místě, na něž šipka ukazuje, leží pod kaménky hlavního průřezu, kdežto znaménko  značí, že kaménky ty na dotčených kaménkách hlavního průřezu leží. Jsou-li u toho kterého průřezu jednotlivé kaménky opatřeny malým křížkem nebo čísly, tož má tím býti poukázáno na kaménky, na nichž jest stejné znaménko nebo tože číslo. Označením: Pag. 1, Pag. 2 atd. poukazuje se na stránku vzorkového sešitu, na níž se nalézá vyobrazení dotčené stavby.

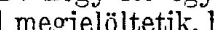
Servendosi delle sezioni di questo fascicolo si voglia avvertire che tutte le pietre che oltrepassano la linea sezionale sono tratteggiate in nero, e che il segno *D* significa: qui sono da porsi una sull'altra due pietre eguali; il segno *B*: qui v'è un arco; il segno $\frac{1}{2}B$: qui v'è un mezzo arco; il segno *SB*: qui v'è un arco acuto; il segno $\frac{1}{2}SB$: qui v'è un mezzo arco acuto. Quando nelle sezioni parziali v'ha il segno  questo vuol significare che le pietre della sezione parziale giacciono, nei punti ai quali accenna la freccia, sotto alle pietre della sezione principale; all'incontro il segno  significa che le pietre giacciono sulle pietre relative della sezione principale. Se in una qualche sezione v'hanno delle singole pietre munite di crocette e di numeri, questi segni rinviano il costruttore a delle pietre analoghe munite d'eguali crocette o numeri. Le indicazioni Pag. 1, Pag. 2, e così via, rimandano alla pagina del fascicolo di modelli sulla quale si trova la figura del rispettivo edificio.

En el uso de los cortes transversales de este cuaderno se tendrá presente, que todas las piedras que sobresalen de la línea de intersección están marcadas con trazos negros y que el signo *D* significa, que en el lugar correspondiente hay superpuestas dos piedras iguales, el signo *B* que en el sitio respectivo hay un arco, ó $\frac{1}{2}B$ medio arco, y *SB* una ojiva, ó $\frac{1}{2}SB$ media ojiva. Cuando en los cortes parciales aparece el signo  significa que las piedras del corte parcial se hallan colocadas debajo de las piedras del corte principal, en el sitio señalado por la flecha, mientras que el signo  indica por el contrario, que las piedras del corte parcial se hallan colocadas encima de las piedras correspondientes del corte principal. Las piedras marcadas con crucecitas ó con números, que hay en algunos cortes, hacen referencia á las piedras señaladas con el mismo signo ó número. Las indicaciones: pág. 1, pág. 2, etc., se refieren á la página del cuaderno de Modelos, que representa la figura del respectivo edificio.

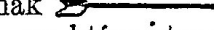
Ezen füzet kereszmetseteinek használatánál megfigyelendő, hogy valamennyi a kereszmetsetvonalon kimagasló kövek feketére vannak sávozva és hogy a *D* jel azt jelenti: miszerint itt két egyforma kő egymás felett fekszik, a „*B*“ jel pedig: hogy itt egy ív. vagy $\frac{1}{2}B$: hogy itt egy félív fekszik: és „*SB*“: hogy itt egy csúcsív vagy $\frac{1}{2}SB$: hogy itt egy fél csúcsív fekszik. Ha a részmetseteknél egy  jel látható, ezáltal megjelöltetik, hogy a részmetsetnek kövei azon a helyen, a melyre a nyíl reámutat, a főmetset kövei alatt fekszenek, a  jel által ellenben megjelöltetik, hogy a kövek a főmetset megfelelő kövein fekszenek. Ha egy metsetnél egyes kövek kis keresztekkel vagy számokkal vannak ellátva, úgy ezáltal oly kövekre utalva legyen melyek ugyanazon jellel vagy számmal vannak ellátva. A pag. 1, pag. 2 stb. jegyek által a mintafüzet azon oldalára utaltatik, a melyen a megfelelő építmény rajza ábrázolva van.

Przy użyciu poprzecznych przekrojów tego zeszytu trzeba zważać na to, że wszystkie ponad linię sieczną wystające kamienie pomalowane są na czarno i że znak *D* znaczy: tu leżą dwa równe kamyki jeden nad drugim, znak *B*: tu leży łuk albo $\frac{1}{2}$ łuku: pół łuku, a *SB*: tu leży łuk spiczasty albo $\frac{1}{2}SB$: pół łuku spiczastego. Jeśli przy przekroju częściowym podany jest znak  to wskazuje on na to, że kamyki przekroju częściowego leżą na tem miejscu, na które strzałka wskazuje, a więc pod kamykami głównego przekroju, znak  wskazuje na to, że kamyki leżą na odnośnych kamykach głównego przekroju. Jeśli przy jakimś przekroju opatrzone zostały pojedyncze kamyki małemi krzyżykami lub numerami, to przez to wskazuje się na te kamyki, które oznaczone są tym samym znakiem lub tym samym numerem. Znaki: Pag. 1, Pag. 2, itd. wskazują na tę stronicę zeszytu z wzorkami, na której się znajduje rysunek odnośnej budowli.